





1. CONEXIONES METRICAS

1.1	Conexiones plásticas	6
1.1.1	Válvulas Manuales/Bola	24
1.1.2	Conexiones Plásticas con Función de Cierre	26
1.1.3	Conexiones Plásticas con Función Anti retorno	28
1.2	Conexiones Plásticas Mini	30
1.3	Conexiones Metálicas	34
1.4	Conexiones en Acero Inoxidable	40

2. CONEXIONES PULGADAS

2.1	Conexiones plásticas	44
2.2	Conexiones Metálicas	53

3. ACCESORIOS Y ADAPTADORES

3.1	Silenciadores	58
3.2	Coples Rápidos	60
3.3	Adaptadores	61
3.4	Pistolas y Corta Tubing	63

4. MANGUERAS

4.1	Manguera Poliuretano	65
4.3	Manguera Polietileno	73
4.4	Manguera de Nylon	76
4.5	Manguera Anti Chispa	79
4.6	Tabla de compatibilidad Química	81

PRECAUCIONES

 LEA LAS SIGUIENTES PRECAUCIONES ANTES DE SELECCIONAR Y UTILIZAR NUESTROS PRODUCTOS.

ADVERTENCIA.

1. Utilizar únicamente aire o agua (Se pueden utilizar otros fluidos). Consultar con el fabricante para otro tipo de fluidos
2. No utilizar conexiones plásticas, en lugares donde estas estén expuestas a chispas. si es el caso utilizar conexiones metálicas únicamente.
3. Cuando utilice agua o aceite caliente a una temperatura de 60°C o mayor, utilizar conexiones resistentes a altas temperaturas para evitar daños en el producto.
4. No aplique tensión, flexión, etc. a la unión de la tubería. De lo contrario, existe riesgo de causar daños al cuerpo del conector.

ADVERTENCIA.

1. Precaución.

Nota 1. Cuando utilice tubería que no sea de la marca registrada de la empresa “DE WIT”, confirme si la tolerancia del diámetro exterior del tubo es como se muestra en la tabla 1 a continuación.

Tabla 1. - Tolerancia de diámetro exterior

Diámetro	Nylon	Poliuretano
∅ 3mm	-	±0.1
∅ 4mm	±0.1	±0.15
∅ 6mm	±0.1	±0.15
∅ 8mm	±0.1	±0.15
∅ 10mm	±0.1	±0.15
∅ 12mm	±0.1	±0.15
∅ 14mm	±0.1	±0.15
∅ 16mm	±0.1	±0.15

Tabla 1. - Tolerancia de diámetro exterior

Diámetro	Nylon	Poliuretano
∅ 3mm	-	±0.1
∅ 4mm	±0.1	±0.15
∅ 6mm	±0.1	±0.15
∅ 8mm	±0.1	±0.15
∅ 10mm	±0.1	±0.15
∅ 12mm	±0.1	±0.15
∅ 14mm	±0.1	±0.15
∅ 16mm	±0.1	±0.15

2. Precauciones de instalación.

1. Asegúrese que la superficie de corte en la tubería este completamente vertical, que no existan daños en el exterior y que la tubería no este ovalada.
2. Cuando se inserte la tubería, consulte la tabla 2 para las dimensiones, Si el tubo no esta insertado (Tamaño C), puede causar fugas en la conexión.
3. Una vez que la tubería que esté insertada, tire el tubo para confirmar que no se puede extraer.

Tabla 2. - Tipo Métrico.

Métrico	ø4	ø6	ø8	ø10	ø12	ø14	ø16
Pulgadas	ø5/32, ø3/16	ø1/4	ø5/16	ø3/8	ø1/2		ø5/8
C (mm)	15	16	18.5	20	23	23.5	23.5

Tabla 2. - Tipo Mini.

	ø3	ø4	ø6
C (mm)	10	12	12.5

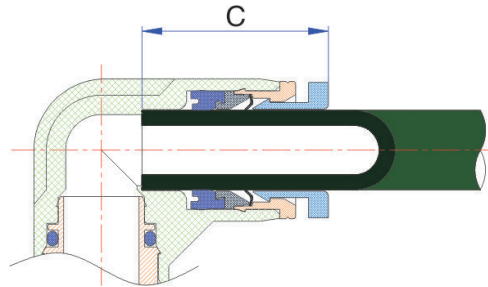

3. Precauciones para desconectar la tubería.

1. Antes de desconectar la tubería, asegúrese que la presión interna sea igual a cero.
2. Presione le anillo de liberación uniformemente hasta el fondo y retire la tubería. Si el anillo de liberación no se presiona correctamente, existe la posibilidad de que la tubería no se extraiga correctamente o pueda causar daños a la misma.

4. Precauciones para la instalación de la conexión.

1. Utilizar la herramienta adecuada para sujetar el cuerpo de la conexión rápida con el hexágono.
2. Al apretar la conexión, consulte el par de apriete recomendado a la tabla 3, si el par de torsión utilizado excede el par de apriete recomendado, puede causar daños a la cuerda generando fuga

Tabla 3. - Tolerancia de diámetro exterior

Tamaño de Rosca	Par de Apriete	Color del Sello	Material de la Junta
M3X0.5	0.7N · m (7kgf · cm)	BLANCO	NBR
M5X0.8	1 ~ 1.5N · m(10 ~ 15kgf · cm)		
M6X1.0	1.8 ~ 2.3N · m(18 ~ 23kgf · cm)		
R1/8	7 ~ 9N · m(70 ~ 90kgf · cm)		
R1/4	12 ~ 14N · m(120 ~ 140kgf · cm)		
R3/8	22 ~ 24N · m(220 ~ 240kgf · cm)		
R1/2	28 ~ 30N · m(280 ~ 300kgf · cm)	GRIS	NBR
No.10-32 UNF	1.5 ~ 1.9N · m(15 ~ 19kgf · cm)		
1/16-28NPT	7 ~ 9N · m(70 ~ 90kgf · cm)		
1/8-27NPT	7 ~ 9N · m(70 ~ 90kgf · cm)		
1/4-18NPT	12 ~ 14N · m(120 ~ 140kgf · cm)		
3/8-NPT	22 ~ 24N · m(220 ~ 240kgf · cm)		
1/2-14NPT	28 ~ 30N · m(280 ~ 300kgf · cm)		

CONEXIONES PLÁSTICAS

Métrico - Tubo \varnothing 4 a 16 mm D.E.

Características.

- Todas las cuerdas R incluyen teflón adherido.
- Las cuerdas G incluyen O-Ring de NBR.
- Amplia variedad de accesorios en diferentes diámetros.
- El cuerpo de latón niquelado previene la corrosión y contaminación.
- Amplia gama de cuerdas.
- Alta vida útil de los materiales.

Figura.

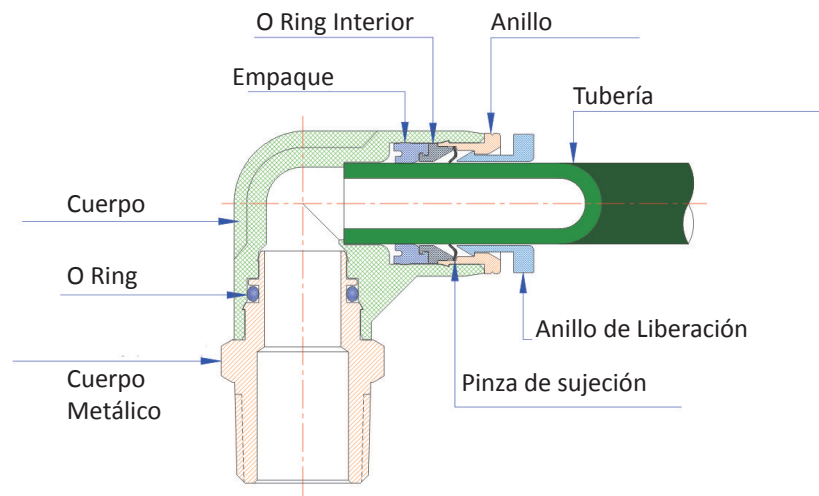

Materiales.

- Cuerpo Metálico: Latón Niquelado
- O-Ring: NBR
- Cuerpo: PBT
- Empaque: NBR
- O-Ring Interior: POM
- Anillo: ZINC
- Tubería: PU, PA, PE
- Anillo de liberación: POM
- Pinza de Sujeción: SUS

Especificaciones Técnicas.

Fluido	Aire, VAcío, Agua
Presión de trabajo	0 ~ 1.2 Mpa
Presión Negativa	750 mm Hg
Temperatura de trabajo	-10° ~ 60 °C
Tamaño de tubería	4, 6, 8, 10, 12, 14, 16 mm
Tamaño de Roscas	M5, R 1/8, R 1/4, R 3/8, R 1/2

CONEXIONES PLÁSTICAS

Métrico - Tubo \varnothing 4 a 16 mm D.E.

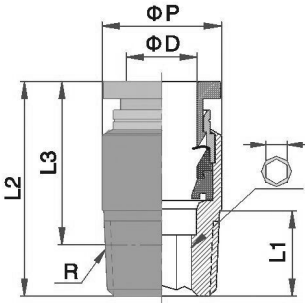

Conexión Recta Macho (Cuerda R)

Modelo (Negro)	Modelo (Blanco)	\varnothing D	R	L1	L2	L3		
012004M5	-	4	M5	3.5	20	16.5	10	2
01200418	-	4	R1/8	7.5	19.5	15.5	10	3
01200428	-	4	R1/4	10	19.5	13.5	14	3
012006M5	-	6	M5	3.5	21	17.5	12	2
01200618	-	6	R1/8	7.5	21	17	12	4
01200628	-	6	R1/4	10	23	17	14	4
01200638	-	6	R3/8	10.5	21	14.5	17	4
01200648	-	6	R1/2	-	-	-	-	-
01200818	-	8	R1/8	7.5	26.5	22.5	14	5
01200828	-	8	R1/4	10	25	19	14	6
01200838	-	8	R3/8	10.5	21.5	15	17	6
01200848	-	8	R1/2	13.5	25.5	17.5	21	6
01201018	-	10	R1/8	7.5	29	25	17	5
01201028	-	10	R1/4	10	31	25	17	6
01201038	-	10	R3/8	10.5	27	20.5	17	8
01201048	-	10	R1/2	13.5	26	18	21	8
01201228	-	12	R1/4	10	34	28	21	6
01201238	-	12	R3/8	10.5	29.5	23	21	8
01201248	-	12	R1/2	13.5	32.5	24.5	21	10
01201438	-	14	-	-	-	-	-	-
01201448	-	14	-	-	-	-	-	-
01201638	-	16	R3/8	10.5	37	30.5	24	12
01201648	-	16	R1/2	13.5	37	28.5	24	12

CONEXIONES PLÁSTICAS

Métrico - Tubo \varnothing 4 a 16 mm D.E.

Conexión Recta Macho Hexagonal (Cuerda R)

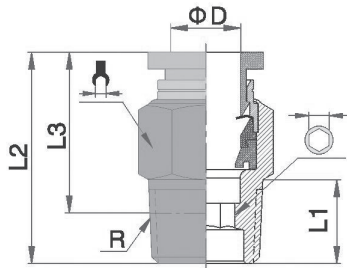

Modelo (Negro)	Modelo (Blanco)	\varnothing D	R	L1	L2	L3		
012104M5	W-012104M5	4	M5	3.5	20	16.5	10	2
01210418	W-01210418	4	R1/8	7.5	18.5	15.5	10	3
01210428	W-01210428	4	R1/4	10	19.5	13.5	14	3
012106M5	W-012106M5	6	M5	3.5	21	17.5	12	2
01210618	W-01210618	6	R1/8	7.5	21	17	12	4
01210628	W-01210628	6	R1/4	10	23	17	14	4
01210638	W-01210638	6	R3/8	10.5	21	14.5	17	4
01210648	W-01210648	6	R1/2	13.5	25	16.5	21	4
01210818	W-01210818	8	R1/8	7.5	26.5	22.5	14	5
01210828	W-01210828	8	R1/4	10	25	19	14	6
01210838	W-01210838	8	R3/8	10.5	21.5	15	17	6
01210848	W-01210848	8	R1/2	13.5	25.5	17.5	21	6
01211018	W-01211018	10	R1/8	7.5	29	25	17	5
01211028	W-01211028	10	R1/4	10	31	25	17	6
01211038	W-01211038	10	R3/8	10.5	27	20.5	17	8
01211048	W-01211048	10	R1/2	13.5	26	18	21	8
01211228	W-01211228	12	R1/4	10	34	28	21	6
01211238	W-01211238	12	R3/8	10.5	29.5	23	21	8
01211248	W-01211248	12	R1/2	13.5	32.5	24.5	21	10
01211438	W-01211438	14	R3/8	10.5	35	28.5	22	10
01211448	W-01211448	12	R1/2	13.5	33	24.5	22	10
01211638	W-01211638	16	R3/8	10.5	37	30.5	24	10
01211648	W-01211648	16	R1/2	13.5	37	28.5	24	12

Conexión Recta Macho Hexagonal (Cuerda G)

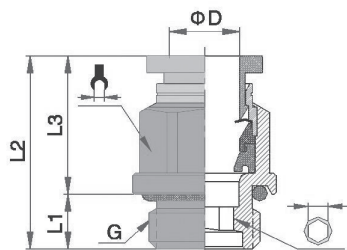

Modelo (Negro)	Modelo (Blanco)	\varnothing D	G	L1	L2	L3		
01210418-G	-	4	G1/8	5.5	19.5	14	10	3
01210428-G	-	4	G1/4	6.5	19.5	13	12	3
01210618-G	-	6	G1/8	5.5	20.5	15	12	4
01210628-G	-	6	G1/4	6.5	21.5	15	12	4
01210638-G	-	6	G3/8	7.5	21	13.5	16	4
01210648-G	-	6	G1/2	10	23.5	13.5	17	4
01210818-G	-	8	G1/8	5.5	26	20.5	14	5
01210828-G	-	8	G1/4	6.5	23	16.5	14	6
01210838-G	-	8	G3/8	7.5	24	16.5	16	6
01210848-G	-	8	G1/2	10	25	15	19	6
01211018-G	-	10	G1/8	5.5	28.5	23	17	5
01211028-G	-	10	G1/4	6.5	29.5	23	17	6
01211038-G	-	10	G3/8	7.5	26	18.5	17	8
01211048-G	-	10	G1/2	10	26	16	19	8
01211228-G	-	12	G1/4	6.5	31.5	25	20	6
01211238-G	-	12	G3/8	7.5	32.5	25.5	20	8
01211248-G	-	12	G1/2	10	30.5	20.5	20	10

Conexión Codo Macho (Cuerda R)



Modelo (Negro)	Modelo (Blanco)	\varnothing D	R	L1	L2	L3	L4	\varnothing P	
012204M5	W-012204M5	4	M5	3.5	18.5	18.5	20.5	11	12
01220418	W-01220418	4	R1/8	7.5	18.5	21	22.5	11	12
01220428	W-01220428	4	R1/4	10	18.5	24	23.5	11	14
012206M5	W-012206M5	6	M5	3.5	19.5	19.5	22.5	13	12
01220618	W-01220618	6	R1/8	7.5	19.5	22	24.5	13	12
01220628	W-01220628	6	R1/4	10	19.5	25	25.5	13	14
01220638	W-01220638	6	R3/8	10.5	19.5	26	26	13	17
01220648	W-01220648	6	R1/2	13.5	19.5	29.5	27.5	13	21
01220818	W-01220818	8	R1/8	7.5	23	25	28.5	14.5	14
01220828	W-01220828	8	R1/4	10	23	27.5	29	14.5	14
01220838	W-01220838	8	R3/8	10.5	23	28.5	29	14.5	17
01220848	W-01220848	8	R1/2	13.5	23	32	31	14.5	21
01221018	W-01221018	10	R1/8	7.5	27	27.5	32.5	18.5	17
01221028	W-01221028	10	R1/4	10	27	30	33	18.5	17
01221038	W-01221038	10	R3/8	10.5	27	30.5	33	18.5	17
01221048	W-01221048	10	R1/2	13.5	27	34	35.6	18.5	21
01221228	W-01221228	12	R1/4	10	29.5	30.5	35	21	17
01221238	W-01221238	12	R3/8	10.5	29.5	31	35	21	17
01221248	W-01221248	12	R1/2	13.5	29.5	34.5	36.5	21	21
01221438	W-01221438	14	R3/8	11	30	37.5	43	23	19
01221448	W-01221448	14	R1/2	14	30	40	43	23	21
01221638	W-01221638	16	R3/8	11	31.5	39	45	26	21
01221648	W-01221648	16	R1/2	14	31.5	41.5	46	26	21

Conexión Codo Macho (Cuerda G)

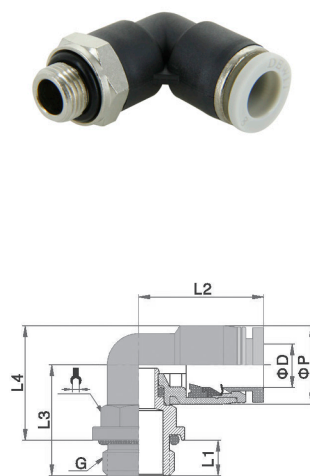



Modelo	Modelo (Blanco)	\varnothing D	G	L1	L2	L3	L4	\varnothing P	
01220418-G	-	4	G1/8	5.5	18.5	21	21	11	14
01220428-G	-	4	G1/4	6.5	18.5	22	21	11	17
01220618-G	-	6	G1/8	5.5	19.5	22	23	13	14
01220628-G	-	6	G1/4	6.5	19.5	23	23	13	17
01220638-G	-	6	G3/8	7.5	19.5	25	24	13	20
01220648-G	-	6	-	-	-	-	-	-	-
01220818-G	-	8	G1/8	5.5	23	24.5	26	14.5	14
01220828-G	-	8	G1/4	6.5	23	25.5	26	14.5	17
01220838-G	-	8	G3/8	7.5	23	27.5	27	14.5	20
01220848-G	-	8	G1/2	10	23	30	27	14.5	24
01221018-G	-	10	G1/8	5.5	27	26.5	30	18.5	17
01221028-G	-	10	G1/4	6.5	27	27.5	30	18.5	17
01221038-G	-	10	G3/8	7.5	27	29.5	31	18.5	20
01221048-G	-	10	G1/2	10	27	32	31	18.5	24
01221228-G	-	12	G1/4	6.5	29.5	28	32	21	17
01221228-G	-	12	G3/8	7.5	29.5	30	33	21	20
01221248-G	-	12	G1/2	10	29.5	32.5	33	21	24

CONEXIONES PLÁSTICAS

Métrico - Tubo \varnothing 4 a 16 mm D.E.

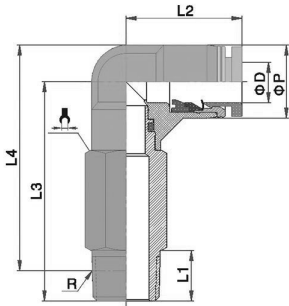
Conexión Codo Macho Extendido (Cuerda R)



Modelo	\varnothing D	R	L1	L2	L3	L4	\varnothing P	
012304M5	4	M5	3.5	18.5	30.5	32.5	11	12
01230418	4	R1/8	7.5	18.5	33	34.5	11	12
01230428	4	R1/4	10	18.5	36	35.5	11	14
012306M5	6	M5	3.5	19.5	33.5	36.5	13	12
01230618	6	R1/8	7.5	18.5	36	38.5	13	12
01230628	6	R1/4	10	18.5	39	39.5	13	14
01230638	6	R3/8	10.5	18.5	40	40	13	17
01230648	6	R1/2	13.5	18.5	43.5	41.5	13	21
01230818	8	R1/8	7.5	23	40.5	44	14.5	14
01230828	8	R1/4	10	23	43	44.5	14.5	14
01230838	8	R3/8	10.5	23	44	45	14.5	17
01230848	8	R1/2	13.5	23	47.5	46.5	14.5	21
01231018	10	R1/8	7.5	27	47	52	18.5	17
01231028	10	R1/4	10	27	49.5	52.5	18.5	17
01231038	10	R3/8	10.5	27	50	53	18.5	17
01231048	10	R1/2	13.5	27	53.5	54.5	18.8	21
01231228	12	R1/4	10	29.5	52.5	57	21	17
01231238	12	R3/8	10.5	29.5	53	57	21	17
01231248	12	R1/2	13.5	29.5	56.5	59	21	21

Conexión (T) Orientable Tubo-Rosca Macho Lateral (Cuerda R)

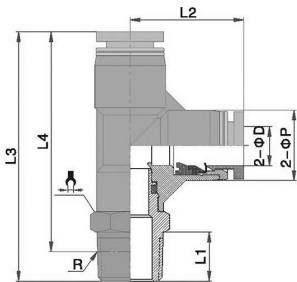

Modelo	\varnothing D	R	L1	L2	L3	L4	\varnothing P	
012404M5	4	M5	3.5	18.5	37	33.5	11	12
01240418	4	R1/8	7.5	18.5	40	36	11	12
01240428	4	R1/4	10	18.5	43	37	11	14
012406M5	6	M5	3.5	19.5	39	35.5	13	12
01240618	6	R1/8	7.5	19.5	42	38	13	12
01240628	6	R1/4	10	19.5	45	39	13	14
01240638	6	R3/8	10.5	19.5	45.5	39	13	17
01240648	6	R1/2	13.5	19.5	49	41	13	21
01240818	8	R1/8	7.5	23	48.5	44.5	14.5	14
01240828	8	R1/4	10	23	51	45	14.5	14
01240838	8	R3/8	10.5	23	51.5	45	14.5	17
01240848	8	R1/2	13.5	23	55	47	14.5	21
01241018	10	R1/8	7.5	27	55	51	18.5	17
01241028	10	R1/4	10	27	57	51	18.5	17
01241038	10	R3/8	10.5	27	57.5	51	18.5	17
01241048	10	R1/2	13.5	27	61	53	18.5	21
01241228	12	R1/4	10	29.5	60	54	21	17
01241238	12	R3/8	10.5	29.5	60.5	54	21	17
01241248	12	R1/2	13.5	29.5	64	56	21	21
01241438	14	R3/8	11	30.5	67.5	61	23	19
01241448	14	R1/2	14	30.5	71	63	23	21
01241638	16	-	-	-	-	-	-	-
01241648	16	-	-	-	-	-	-	-

Conexión (T) Orientable Tubo-Rosca Macho Central (Cuerda R)



Modelo (Negro)	Modelo (Blanco)	\varnothing D	R	L1	L2	L3	L4	P	
012504M5	W-012504M5	4	M5	3.5	37	18.5	20.5	11	12
01250418	W-01250418	4	R1/8	7.5	37	21	22.5	11	12
01250428	W-01250428	4	R1/4	10	37	24	23.5	11	14
012506M5	W-012506M5	6	M5	3.5	39	19.5	22.5	13	12
01250618	W-01250618	6	R1/8	7.5	39	22	24.5	13	12
01250628	W-01250628	6	R1/4	10	39	25	25.5	13	14
01250638	W-01250638	6	R3/8	10.5	39	26	26	13	17
01250648	W-01250648	6	1/2	13.5	39	29.5	27.5	13	21
01250818	W-01250818	8	R1/8	7.5	46	25	28.5	14.5	14
01250828	W-01250828	8	R1/4	10	46	27.5	29	14.5	14
01250838	W-01250838	8	R3/8	10.5	46	28.5	29	14.5	17
01250848	W-01250848	8	1/2	13.5	46	32	31	14.5	21
01251018	W-01251018	10	R1/8	7.5	54.5	27.5	32.5	18.5	17
01251028	W-01251028	10	R1/4	10	54.5	30	33	18.5	17
01251038	W-01251038	10	R3/8	10.5	54.5	30.5	33	18.5	17
01251048	W-01251048	10	1/2	13.5	54.5	34	35	18.5	21
01251228	W-01251228	12	R1/4	10	59	30.5	35	21	17
01251238	W-01251238	12	R3/8	10.5	59	31	35	21	17
01251248	W-01251248	12	1/2	13.5	59	34.5	36.5	21	21
01251438	W-01251438	14	3/8	11	60	37	42	23	19
01251448	W-01251448	14	1/2	14	60	40.5	44	23	21
01251638	W-01251638	16	3/8	11	61	42	48.5	26	21
01251648	W-01251648	16	1/2	14	61	54.5	50	26	21

Conexión (T) Orientable Tubo-Rosca Macho Central (Cuerda G)

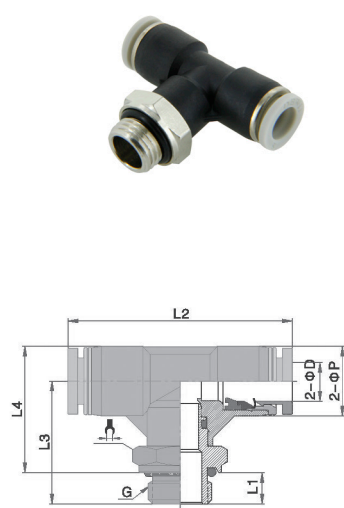

Modelo	Modelo (Blanco)	\varnothing D	G	L1	L2	L3	L4	\varnothing P	
01250418-G	-	4	G1/8	5.5	37	21	21	11	14
01250428-G	-	4	G1/4	6.5	37	22	21	11	17
01250618-G	-	6	G1/8	5.5	39	22	23	13	14
01250628-G	-	6	G1/4	6.5	39	23	23	13	17
01250638-G	-	6	G3/8	7.5	39	25	24	13	20
01250648-G	-	6	G1/2	-	-	-	-	-	-
01250818-G	-	8	G1/8	5.5	46	24.5	26	14.5	14
01250828-G	-	8	G1/4	6.5	46	25.5	26	14.5	17
01250838-G	-	8	G3/8	7.5	46	27.5	27	14.5	20
01250848-G	-	8	G1/2	10	46	30	27	14.5	24
01251018-G	-	10	G1/8	5.5	54.5	26.5	30	18.5	17
01251028-G	-	10	G1/4	6.5	54.5	27.5	30	18.5	17
01251038-G	-	10	G3/8	7.5	54.5	29.5	32	18.5	20
01251048-G	-	10	G1/2	10	54.5	32	31	18.5	24
01251228-G	-	12	G1/4	6.5	59	28	32	21	17
01251238-G	-	12	G3/8	7.5	59	30	33	21	20
01251248-G	-	12	G1/2	10	59	32.5	33	21	24

CONEXIONES PLÁSTICAS

Métrico - Tubo Ø 4 a 16 mm D.E.

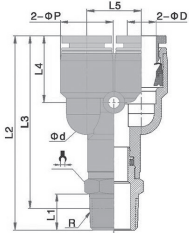

Conexión (Y) Orientable Macho (Cuerda R)

Modelo (Negro)	Modelo (Blanco)	Ø D	R	L1	L2	L3	L4	L5	Ø P	Icono
012604M5	W-012604M5	4	M5	3.5	39	35.5	14	11	11	12
01260418	W-01260418	4	R1/8	7.5	41.5	37.5	14	11	11	12
01260428	W-01260428	4	R1/4	10	44.5	38.5	14	11	11	14
012606M5	W-012606M5	6	M5	3.5	42	38.5	15	13	13	12
01260618	W-01260618	6	R1/8	7.5	45	41	15	13	13	12
01260628	W-01260628	6	R1/4	10	47.5	41.5	15	13	13	14
01260638	W-01260638	6	R3/8	10.5	48.5	42	15	13	13	17
01260648	W-01260648	6	R1/2	13.5	52	44	15	13	13	21
01260818	W-01260818	8	R1/8	7.5	51	47	18	14.5	14.5	14
01260828	W-01260828	8	R1/4	10	53.5	47.5	18	14.5	14.5	14
01260838	W-01260838	8	R3/8	10.5	54.5	48	18	14.5	14.5	17
01260848	W-01260848	8	R1/2	13.5	58	49.5	18	14.5	14.5	21
01261018	W-01261018	10	R1/8	7.5	56.5	52.5	21	18.5	18.5	17
01261028	W-01261028	10	R1/4	10	59	53	21	18.5	18.5	17
01261038	W-01261038	10	R3/8	10.5	59.5	53	21	18.5	18.5	17
01261048	W-01261048	10	R1/2	13.5	63	55	21	18.5	18.5	21
01261228	W-01261228	12	R1/4	10	64	58	21.5	21	21	17
01261238	W-01261238	12	R3/8	10.5	64.5	58	21.5	21	21	17
01261248	W-01261248	12	R1/2	13.5	68	60	21.5	21	21	21
01261438	W-01261438	14	R3/8	11	65.5	59	22	23	23	19
01261448	W-01261448	14	R1/2	14	69	60.5	22	23	23	21
01261638	W-01261638	16	R3/8	11	65.5	59	22	26	26	21
01261648	W-01261648	16	R1/2	14	69	61	22	26	26	21

Conexión (Y) Orientable Macho (Cuerda G)

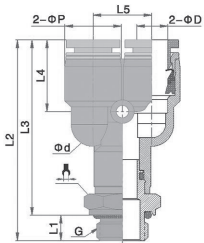

Modelo	Modelo (Blanco)	Ø D	G	L1	L2	L3	L4	L5	Ø P	Icono
01260418-G	-	4	G1/8	5.5	41.5	36	14	11	11	14
01260428-G	-	4	G1/4	6.5	42.5	36	14	11	11	17
01260618-G	-	6	G1/8	5.5	44.5	39	15	13	13	14
01260628-G	-	6	G1/4	6.5	45.5	39	15	13	13	17
01260638-G	-	6	G3/8	7.5	47.5	40	15	13	13	20
01260648-G	-	6	-	-	-	-	-	-	-	-
01260818-G	-	8	G1/8	5.5	50.5	45	18	14.5	14.5	14
01260828-G	-	8	G1/4	6.5	51.5	45	18	14.5	14.5	17
01260838-G	-	8	G3/8	7.5	53.5	45	18	14.5	14.5	20
01260848-G	-	8	G1/2	10	56	45	18	14.5	14.5	24
01261018-G	-	10	G1/8	5.5	55.5	50	21	18.5	18.5	17
01261028-G	-	10	G1/4	6.5	56.5	50	21	18.5	18.5	17
01261038-G	-	10	G3/8	7.5	58.5	51	21	18.5	18.5	20
01261048-G	-	10	G1/2	10	61	51	21	18.5	18.5	24
01261248-G	-	12	G1/2	10	66	56	21.5	21	21	24

CONEXIONES PLÁSTICAS

Métrico - Tubo \varnothing 4 a 16 mm D.E.

Banjo (Cuerda R)

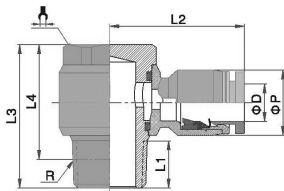

Modelo	\varnothing D	R	L1	L2	L3	L4	\varnothing P	🔩
012704M5	4	M5	4	20	17	16	11	8
01270418	4	R1/8	7	23	24	20	11	12
01270428	4	R1/4	9.5	25	26.5	20.5	11	14
012706M5	6	M5	4	21.5	17	13	13	8
01270618	6	R1/8	7	23	24	20	13	12
01270628	6	R1/4	9.5	25	26.5	20.5	13	14
01270638	6	R3/8	10.5	27	32	25.5	13	19
01270648	6	R1/2	14	33	39	31	14.5	24
01270818	8	R1/8	7	26.5	24	20	14.5	12
01270828	8	R1/4	9.5	29	26.5	20.5	14.5	14
01270838	8	R3/8	10.5	30.5	32	25.5	14.5	19
01270848	8	R1/2	14	33	39	31	14.5	24
01271018	10	R1/8	7	29	24	20	18.5	12
01271028	10	R1/4	9.5	31	26.5	20.5	18.5	14
01271038	10	R3/8	10.5	32	32	25.5	18.5	19
01271048	10	R1/2	14	34.5	39	31	18.5	24
01271228	12	R1/4	9.5	33	26.5	20.5	21	14
01271238	12	R3/8	10.5	33.5	32	25.5	21	19
01271248	12	R1/2	14	36.5	39	31	21	24

Banjo (Cuerda R)

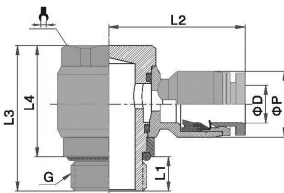



Modelo	\varnothing D	G	L1	L2	L3	L4	\varnothing P	🔩
01270418-G	4	G1/8	5	23	23.5	18.5	-	12
01270428-G	4	G1/4	7	25	27	20	-	14
01270418-G	6	G1/8	5	26.5	23.5	18.5	-	12
01270628-G	6	G1/4	7	29	27	20	-	14
01270638-G	6	G3/8	7.5	30.5	32	24.5	-	19
01270648-G	6	G1/2	10	33	39	29	-	24
01270818-G	8	G1/8	5	29	23.5	18.5	-	12
01270828-G	8	G1/4	7	31	27	20	-	14
01270838-G	8	G3/8	7.5	32	32	24.5	-	19
01270848-G	8	G1/2	10	34.5	39	29	-	24
01271018-G	10	G1/8	7	33	27	20	-	14
01271028-G	10	G1/4	7.5	35	32	24.5	-	19
01271038-G	10	G3/8	10	36.5	39	29	-	24
01271048-G	10	G1/2	-	-	-	-	-	-
01271228-G	12	G1/4	10	39	39	29	-	24
01271238-G	12	G3/8	10	39	39	29	-	24
01271248-G	12	G1/2	-	-	-	-	-	-

CONEXIONES PLÁSTICAS

Métrico - Tubo \varnothing 4 a 16 mm D.E.

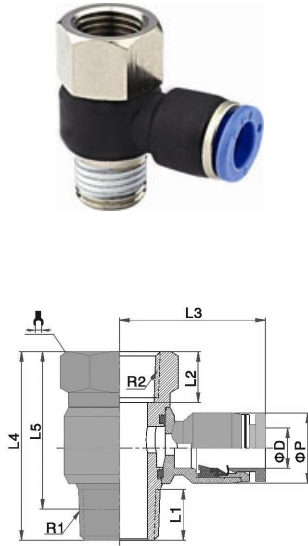
Banjo Conexión Superior (Cuerda R)



Modelo	$\varnothing D$	R1	R2	L1	L2	L3	L4	L5	$\varnothing P$	
012804M5	4	M5		4	5	20	20	16.5	11	8
01280418	4	R1/8			7	23	28	24	11	14
01280428	4	R1/4			9.5	25	33	27	11	17
01280618	6	M5		4	5	21.5	20	16.5	13	8
01280628	6	R1/8			7	23	28	24	13	14
01280638	6	R1/4			9.5	25	33	27	13	17
01280648	6	R3/8			10.5	27	39	32.5	13	21
01280658	6	R1/2			14	33	46.5	38.5	14.5	24
01280818	8	R1/8			7	26.5	28	24	14.5	14
01280828	8	R1/4			9.5	29	33	27	14.5	17
01280848	8	R3/8			10.5	30.5	39	32.5	14.5	21
01280848	8	R1/2			14	33	46.5	38.5	14.5	24
01281018	10	R1/8			7	29	30.5	26.5	18.5	14
01281028	10	R1/4			9.5	31	33	27	18.5	17
01281038	10	R3/8			10.5	32	39	32.5	18.5	21
01281048	10	R1/2			14	34.5	46.5	38.5	18.5	24
01281228	12	R1/4			9.5	33	35	29	21	17
01281238	12	R3/8			10.5	35	39	32.5	21	21
01281248	12	R1/2			14	36.5	46.5	38.5	21	24

Conexión Codo Hembra (Cuerda R)

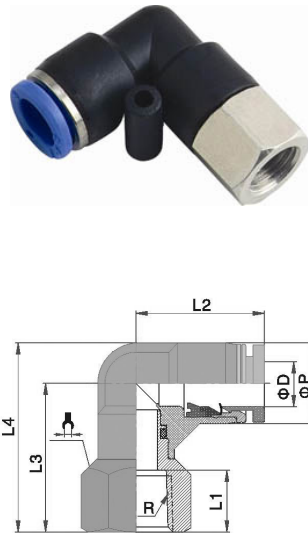

Modeloz	$\varnothing D$	R	L1	L2	L3	L4	$\varnothing P$	
012904M5	4	M5	5	18.5	17	25.5	11	12
01290418	4	R1/8	8.5	18.5	20	25.5	11	14
01290428	4	R1/4	11	18.5	23	28.5	11	17
012906M5	6	M5	5	19.5	18	24.5	13	12
01290618	6	R1/4	11	19.5	24	30.5	13	17
01290628	6	R3/8	11.5	19.5	25	32	13	20
01290638	6	-	-	-	-	-	-	-
01290648	6	-	-	-	-	-	-	-
01290818	8	R1/8	8.5	23	23.5	30.5	14.5	14
01290828	8	R1/4	11	23	26.5	33.5	14.5	17
01290838	8	R3/8	11.5	23	28	35	14.5	20
01290848	8	R1/2	14	23	31.5	38.5	14.5	24
01291018	10	R1/8	8.5	27	25.5	34.5	18.5	17
01291028	10	R1/4	11	27	28.5	37.5	18.5	17
01291038	10	R3/8	11.5	27	29	38	18.5	20
01291048	10	R1/2	14	27	33.5	42.5	18.5	24
01291228	12	R1/4	11	29.5	29	39.5	21	17
01291238	12	R3/8	11.5	29.5	29.5	40	21	20
01291248	12	R1/2	14	29.5	34	44.5	21	24

CONEXIONES PLÁSTICAS

Métrico - Tubo \varnothing 4 a 16 mm D.E.

Conexión Recta Hembra (Cuerda R)

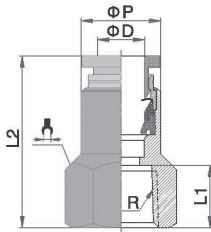

Modelo (Negro)	Modelo (Blanco)	\varnothing D	R	L1	L2		
013004M5	W-013004M5	4	M5	5	21.5	10	10
01300418	W-01300418	4	R1/8	8.5	24.5	10	14
01300428	W-01300428	4	R1/4	11	27	10	17
013006M5	W-013006M5	6	M5	5	22	12	12
01300618	W-01300618	6	M6	5	22	12	12
01300628	W-01300628	6	R1/8	8.5	25.5	12	14
01300638	W-01300638	6	R1/4	11	28	12	17
01300648	W-01300648	6	R3/8	11.5	28.5	12	20
01300818	W-01300818	8	R1/8	8.5	27.5	14	14
01300828	W-01300828	8	R1/4	11	30	14	17
01300838	W-01300838	8	R3/8	11.5	30.5	14	20
01300848	W-01300848	8	R1/2	14	33	14	24
01301018	W-01301018	10	R1/8	8.5	30	17	17
01301028	W-01301028	10	R1/4	11	32.5	17	17
01301038	W-01301038	10	R3/8	11.5	33	17	20
01301048	W-01301048	10	R1/2	14	35.5	17	24
01301228	W-01301228	12	R1/4	11	35	20	20
01301238	W-01301238	12	R3/8	11.5	35.5	20	20
01301248	W-01301248	12	R1/2	14	38	20	24

Conexión Recta Hembra (Cuerda G)

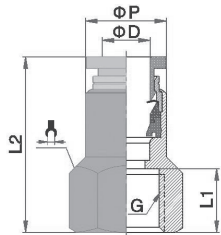

Modelo	Modelo (Blanco)	\varnothing D	G	L1	L2	\varnothing P	
01300418-G	-	4	G1/8	8.5	24.5	10	14
01300428-G	-	4	G1/4	11	27	10	17
01300618-G	-	6	G1/8	8.5	25.5	12	14
01300628-G	-	6	G1/4	11	28	12	17
01300638-G	-	6	G3/8	11.5	28.5	12	20
01300648-G	-	6	-	-	-	-	-
01300818-G	-	8	G1/8	8.5	27.5	14	14
01300828-G	-	8	G1/4	11	30	14	17
01300838-G	-	8	G3/8	11.5	30.5	14	20
01300848-G	-	8	G1/2	14	33	14	24
01301018-G	-	10	G1/8	8.5	30	17	17
01301028-G	-	10	G1/4	11	32.5	17	17
01301038-G	-	10	G3/8	11.5	33	17	20
01301048-G	-	10	G1/2	14	35.5	17	24
01301228-G	-	12	G1/4	11	35	20	20
01301238-G	-	12	G3/8	11.5	35.5	20	20
01301248-G	-	12	G1/2	14	38	20	24

CONEXIONES PLÁSTICAS

Métrico - Tubo \varnothing 4 a 16 mm D.E.

Banjo Regulador de Caudal (Cuerda R)

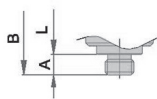
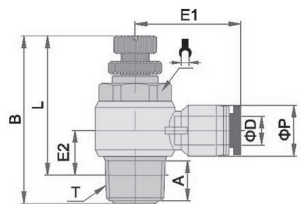

Modelo (Negro)	Modelo (Blanco)	\varnothing D	T	A	E1	E2	B		L		P	
							MIN	MAX	MIN	MAX		
013104M5	W-013104M5	4	M5X0.8	3.5	19.5	7.5	29	32	25.5	28.5	11	8
01310418	W-01310418	4	R1/8	7.5	22.5	10.5	35	40	31	36	13	12
01310428	W-01310428	4	R1/4	10.5	24.5	12.5	41	46.5	35	40.5	13	14
013106M5	W-013106M5	6	M5X0.8	3.5	21.5	8.5	29	32	25.5	28.5	13	8
01310618	W-01310618	6	R1/8	7.5	22.5	10.5	35	40	31	36	13	12
01310628	W-01310628	6	R1/4	10.5	24.5	12.5	41	46.5	35	40.5	13	14
01310638	W-01310638	6	R3/8	11.5	26.5	13.5	46.5	52	40	45.5	13	19
01310648	W-01310648	6	R1/2	15	32	18	54	60	46	52	14.5	24
01310818	W-01310818	8	R1/8	7.5	25	11.5	35	40	31	36	8	12
01310828	W-01310828	8	R1/4	10.5	28	13	41	46.5	35	40.5	8	14
01310838	W-01310838	8	R3/8	11.5	29	14.5	46.5	52	40	45.5	8	19
01310848	W-01310848	8	R1/2	15	32	18	54	60	46	52	8	24
01311018	W-01311018	10	R1/8	7.5	30.5	13.5	35	40	31	36	18.5	12
01311028	W-01311028	10	R1/4	10.5	32.5	15	41	46.5	35	40.5	18.5	14
01311038	W-01311038	10	R3/8	11.5	33	16.5	46.5	52	40	45.5	18.5	19
01311048	W-01311048	10	R1/2	15	36	18	54	60	46	52	18.5	24
01311228	W-01311228	12	R1/4	10.5	33	16.5	41	46.5	35	40.5	21	14
01311238	W-01311238	12	R3/8	11.5	35	18	46.5	52	40	45.5	21	19
01311248	W-01311248	12	R1/2	15	36	19.5	54	60	46	52	21	24

Banjo Regulador de Caudal (Cuerda R)

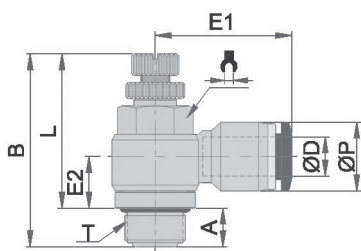

Modelo	Modelo (Blanco)	\varnothing D	T	A	E1	E2	B		L		P	
							MIN	MAX	MIN	MAX		
01310418-G	-	4	G1/8	5.5	22.5	9	35	40	29.5	34.5	13	12
01310428-G	-	4	G1/4	8.5	24.5	10	41	46.5	32.5	38	13	14
01310618-G	-	6	G1/8	5.5	22.5	9	35	40	29.5	34.5	13	12
01310428-G	-	6	G1/4	8.5	24.5	10	41	46.5	32.5	38	13	14
01310638-G	-	6	G3/8	9.5	26.5	11	46.5	52	37	42.5	13	19
01310648-G	-	6	G1/2	12	32	14.5	54	60	42	48	14.5	24
01310818-G	-	8	G1/8	5.5	25	10	35	40	29.5	34.5	14.5	12
01310828-G	-	8	G1/4	8.5	28	10.5	41	46.5	32.5	38	14.5	14
01310838-G	-	8	G3/8	9.5	29	11.5	46.5	52	37	42.5	14.5	19
01310848-G	-	8	G1/2	12	32	14.5	54	60	42	48	14.5	24
01311018-G	-	10	G1/8	5.5	30.5	12	35	40	29.5	34.5	18.5	12
01311028-G	-	10	G1/4	8.5	32.5	12.5	41	46.5	32.5	38	18.5	14
01311038-G	-	10	G3/8	9.5	33	13.5	46.5	52	37	42.5	18.5	19
01311048-G	-	10	G1/2	12	36	14.5	54	60	42	48	18.5	24
01311228-G	-	12	G1/4	8.5	33	14	41	46.5	32.5	38	21	14
01311238-G	-	12	G3/8	9.5	35	15	46.5	52	37	42.5	21	19
01311248-G	-	12	G1/2	12	36	16	54	60	42	48	21	24

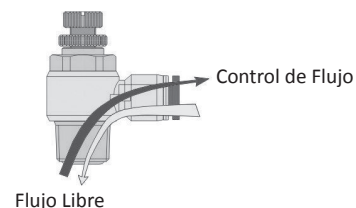
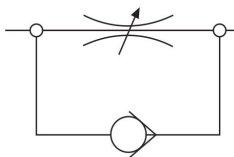

Conexión (T) Orientable Tubo-Rosca Hembra Central (Cuerda R)

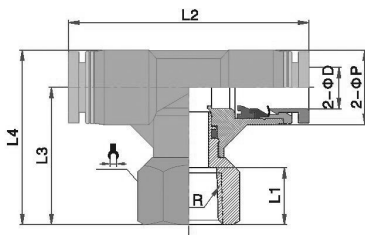

Modelo	φD	R	L1	L2	L3	L4	φP	🔧
013204M5	4	M5	5	37	17	22.5	11	12
01320418	4	R1/8	8.5	37	20	25.5	11	14
01320428	4	R1/4	11	37	23	28.5	11	17
013206M5	6	M5	5	39	18	24.5	13	12
01320618	6	R1/8	8.5	39	21	27.5	13	14
01320628	6	R1/4	11	39	24	30.5	13	17
01320638	6	R3/8	11.5	39	25.5	32	13	20
01320648	6	-	-	-	-	-	-	-
01320818	8	R1/8	8.5	46	23.5	30.5	14.5	14
01320828	8	R1/4	11	46	26.5	33.5	14.5	17
01320838	8	R3/8	11.5	46	28	35	14.5	20
01320848	8	R1/2	14	46	31.5	38.5	14.5	24
01321018	10	R1/8	8.5	54.5	25.5	34.5	18.5	17
01321028	10	R1/4	11	54.5	28.5	37.5	18.5	17
01321038	10	R3/8	11.5	54.5	29	38	18.5	20
01321048	10	R1/2	14	54.5	33.5	42.5	18.5	24
01321228	12	R1/4	11	59	29	39.5	21	17
01321238	12	R3/8	11.5	59	29.5	40	21	20
01321248	12	R1/2	14	59	34	44.5	21	24
01321438	14	R3/8	-	-	-	-	-	-
01321448	14	R1/2	-	-	-	-	-	-
01321638	16	R3/8	-	-	-	-	-	-
01321648	16	R1/2	-	-	-	-	-	-

Conexión Hembra Pasamuros (CuerdaR)

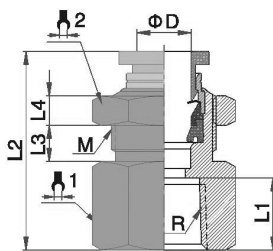

Modelo (Negro)	Modelo (Blanco)	φD	R	L1	L2	L3	L4	M	🔧 ¹	🔧 ²
013304M5	W-013304M5	4	-	-	-	-	-	-	-	-
01330418	W-01330418	4	R1/8	8.5	24.5	5	3.5	M12*1.0	14	14
01330428	W-01330428	4	R1/4	11	27	8	3.5	M12*1.0	17	14
013306M5	W-013306M5	6	-	-	-	-	-	-	-	-
01330618	W-01330618	6	R1/8	8.5	25.5	5.5	4	M14*1.0	17	17
01330628	W-01330628	6	R1/4	11	28.5	5.5	4	M14*1.0	17	17
01330638	W-01330638	6	R3/8	11.5	29	5.5	4	M14*1.0	20	17
01330648	W-01330648	6	-	-	-	-	-	-	-	-
01330818	W-01330818	8	R1/8	8.5	27.5	5.5	4.5	M16*1.0	19	19
01330828	W-01330828	8	R1/4	11	30	5.5	4.5	M16*1.0	19	19
01330838	W-01330838	8	R3/8	11.5	30.5	5.5	4.5	M16*1.0	20	19
01330848	W-01330848	8	R1/2	14	33	5.5	4.5	M16*1.0	24	19
01331018	W-01331018	10	-	-	-	-	-	-	-	-
01331028	W-01331028	10	R1/4	11	32.5	7	5	M18*1.0	21	21
01331038	W-01331038	10	R3/8	11.5	33	7	5	M18*1.0	21	21
01331048	W-01331048	10	R1/2	14	35.5	7	5	M18*1.0	24	21
01331228	W-01331228	12	R1/4	11	35	9	5	M22*1.0	27	27
01331238	W-01331238	12	R3/8	11.5	35.5	9	5	M22*1.0	27	27
01331248	W-01331248	12	R1/2	14	38	9	5	M22*1.0	27	27

CONEXIONES PLÁSTICAS

Métrico - Tubo \varnothing 4 a 16 mm D.E.

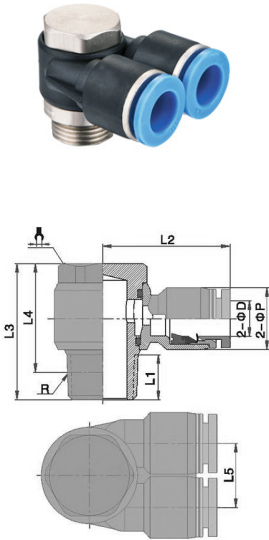

Banjo Doble Horizontal (Cuerda R)

Modelo	ϕ D	R	L1	L2	L3	L4	L5	ϕ P	
01341238	4	M5	4	22.5	17	13	11	11	8
01340418	-	-	-	-	-	-	-	-	-
01340428	-	-	-	-	-	-	-	-	-
013406M5	-	-	-	-	-	-	-	-	-
01340618	6	R1/8	7	24	24	20	13	13	12
01340628	-	-	-	-	-	-	-	-	-
01340638	-	-	-	-	-	-	-	-	-
01340648	-	-	-	-	-	-	-	-	-
01340818	8	R1/8	7	26	24	20	14.5	14.5	12
01340828	8	R1/4	9.5	28	26.5	20.5	14.5	14.5	14
01340838	-	-	-	-	-	-	-	-	-
01340848	-	-	-	-	-	-	-	-	-
01341018	-	-	-	-	-	-	-	-	-
01341028	10	R1/4	9.5	31	26.5	20.5	18.5	18.5	14
01341038	10	R3/8	10.5	33	32	25.5	18.5	18.5	19
01341048	-	-	-	-	-	-	-	-	-
01341228	-	-	-	-	-	-	-	-	-
01341238	12	R3/8	10.5	34	32	25.5	21	21	19
01341248	12	R1/2	14	36.5	39	31	21	21	24

Banjo Doble Orientable (Cuerda R)

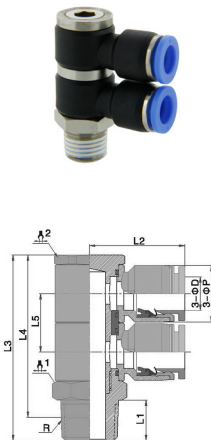

Modelo	ϕ D	R	L1	L2	L3	L4	L5	ϕ P		
013504M5	-	-	-	-	-	-	-	-	-	-
01350418	4	R1/8	8	23.5	43	39	13.5	13	14	14
01350428	4	R1/4	11	23.5	46	40	13.5	13	14	14
013506M5	6	R1/8	8	23.5	43	39	13.5	13	14	14
01350618	6	R1/4	11	23.5	46	40	13.5	13	14	14
01350628	6	R3/8	12	23.5	48	41.5	13.5	13	17	14
01350638	6	-	-	-	-	-	-	-	-	-
01350648	6	-	-	-	-	-	-	-	-	-
01350818	8	R1/8	8	27.5	47	43	15	14.5	17	17
01350828	8	R1/4	11	27.5	50	44	15	14.5	17	17
01350838	8	R3/8	12	27.5	51	44.5	14	14.5	17	17
01350848	8	R1/2	15	27.5	55	47	15	14.5	21	17
01351018	10	R1/4	11	32	58	52	18.5	18.5	21	21
01351028	10	R3/8	12	32	59	52.5	18.5	18.5	21	21
01351038	10	R1/2	15	32	62	54	18.5	18.5	21	21
01351048	10	-	-	-	-	-	-	-	-	-
01351228	12	R1/4	11	35	64.5	58.5	21.5	21	24	24
01351238	12	R3/8	12	35	65.5	59	21.5	21	24	24
01351248	12	R1/2	15	35	68.5	60.5	21.5	21	24	24

CONEXIONES PLÁSTICAS

Métrico - Tubo \varnothing 4 a 16 mm D.E.

Banjo Triple Orientable (Cuerda R)

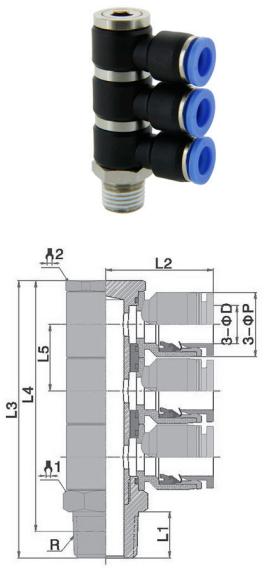

Modelo	\varnothing D	R	L1	L2	L3	L4	\varnothing P	L5		
013604M5	-	-	-	-	-	-	-	-	-	-
01360418	4	R1/8	8	23.5	56.5	52.5	13	13.5	14	14
01360428	4	R1/4	11	23.5	59.5	53.5	13	13.5	14	14
013606M5	-	-	-	-	-	-	-	-	-	-
01360618	6	R1/8	8	23.5	56.5	52.5	13	13.5	14	14
01360628	6	R1/4	11	23.5	59.5	53.5	13	13.5	14	14
01360638	6	R3/8	12	23.5	61.5	55	13	13.5	17	14
01360648	-	-	-	-	-	-	-	-	-	-
01360818	8	R1/8	8	27.5	62	58	14.5	15	17	17
01360828	8	R1/4	11	27.5	65	59	14.5	15	17	17
01360838	8	R3/8	12	27.5	66	59.5	14.5	15	17	17
01360848	8	R1/2	15	27.5	70	62	14.5	15	21	17
01361018	-	-	-	-	-	-	-	-	-	-
01361028	10	R1/4	11	32	76.5	70.5	18.5	18.5	21	21
01361038	10	R3/8	12	32	77.5	71	18.5	18.5	21	21
01361048	10	R1/2	15	32	80.5	72.5	18.5	18.5	21	21
01361228	12	R1/4	11	35	86	80	21	21.5	24	24
01361238	12	R3/8	12	35	87	80.5	21	21.5	24	24
01361248	12	R1/2	15	35	90	82	21	21.5	24	24

Conexión (L) Reductor

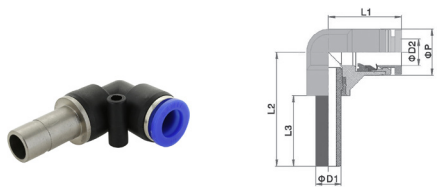

Modelo	\varnothing D1	\varnothing D2	L1	L2	L3	\varnothing P
00610604	6	4	18.5	29	19	11
00610804	-	-	-	-	-	-
00610806	8	6	22	35.5	22	14.5
00611006	-	-	-	-	-	-
00611008	10	8	26.5	39	23.5	18.5
00611208	-	-	-	-	-	-
00611210	12	10	27	42	26.5	18.5

(T) Unión Tubos

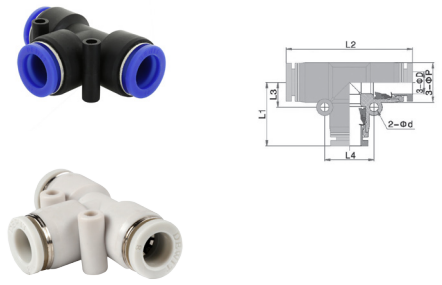

Modelo (Negro)	Modelo (Blanco)	\varnothing D1	\varnothing P	L1	L2	L3	L4	\varnothing d
00620400	W-00620400	4	11	18.5	37	7	14	3.2
00620600	W-00620600	6	13	19	38	8	16	3.2
00620800	W-00620800	8	14.5	23	46	9	18	3.2
00621000	W-00621000	10	18.5	27.5	55	11.5	23	4.2
00621200	W-00621200	12	21	29	58	13	26	4.2
00621400	W-00621400	14	23	30	60	13.5	27	4.2
00621600	W-00621600	16	26	32.5	65	14	28	5.2

CONEXIONES PLÁSTICAS

Métrico - Tubo \varnothing 4 a 16 mm D.E.

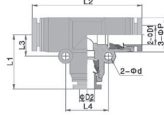

(T) Unión Tubos Reductor

Modelo (Negro)	Modelo (Blanco)	$\varnothing D1$	$\varnothing D2$	$\varnothing P$	L1	L2	L3	L4	$\varnothing d$
00630604	W-00630604	6	4	13	19	38	8	16	3.2
00630804	-	8	4	14.5	22	46	9	18	3.2
00630806	W-00630806	8	6	14.5	22	46	9	18	3.2
00631006	-	10	6	18.5	26	55	11.5	23	4.2
00631008	W-00631008	10	8	18.58	27	55	11.5	23	4.2
00631208	-	12	8	21	29	58	13	26	4.2
00631210	W-00631210	12	10	21	29.5	58	13	26	4.2

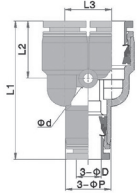

(Y) Unión Tubos

Modelo (Negro)	Modelo (Blanco)	$\varnothing D$	L1	L2	L3	$\varnothing P$	$\varnothing d$
00640400	W-00640400	4	35.5	14	11	11	3.2
00640600	W-00640600	6	38	15	13	13	3.2
00640800	W-00640800	8	44.5	18.5	14.5	14.5	3.2
00641000	W-00641000	10	50	21	18	18.5	4.2
00641200	W-00641200	12	55	22	21	21	4.2
00641400	W-00641400	14	55.5	22	26	26	4.2
00641600	W-00641600	16	-	-	-	-	-

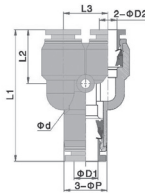

(Y) Unión Tubos Reductor

Modelo (Negro)	Modelo (Blanco)	$\varnothing D2$	$\varnothing D$	L1	L2	L3	$\varnothing P$	$\varnothing d$
00650604	W-00650604	6	4	37	14.5	13	13	3.2
00650806	W-00650806	8	6	43.5	17.5	14.5	14.5	3.2
00651008	W-00651008	10	8	49.5	20.5	18	18.5	4.2
00651210	W-00651210	12	10	45.5	21.5	21	21	4.2

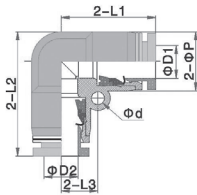

Codo Tubo-tubo

Modelo (Negro)	Modelo (Blanco)	$\varnothing D1$	$\varnothing D2$	L1	L2	L3	$\varnothing P2$	$\varnothing d$
00660400	W-00660400	4	4	18.5	24	7	11	3.2
00660600	W-00660600	6	6	19	25.5	8	13	3.2
00660800	W-00660800	8	8	23	30.5	9	14.5	3.2
00661000	W-00661000	10	10	27.5	37	11.5	18.5	4.2
00661200	W-00661200	12	12	29	39.5	13	21	4.2
00661400	W-00661400	14	14	30	41.5	13.5	23	4.2
00661600	W-00661600	16	16	32.5	45.5	14	26	5.2

CONEXIONES PLÁSTICAS

Métrico - Tubo \varnothing 4 a 16 mm D.E.

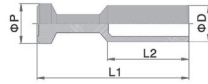

Tapón

Modelo (Negro)	Modelo (Blanco)	\varnothing D	\varnothing P	L1	L2
00670400	W-00670400	4	5	28	15
00670600	W-00670600	6	7	33	16
00670800	W-00670800	8	9	36	18.5
00671000	W-00671000	10	11	42.5	20
00671200	W-00671200	12	13	43	23

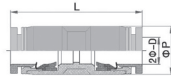

Unión Tubo-tubo

Modelo (Negro)	Modelo (Blanco)	\varnothing D1	L1	L2	\varnothing P	\varnothing d
00680400	W-00680400	4	32.5	13.5	11	3.2
00680600	W-00680600	6	35	16	13	3.2
00680800	W-00680800	8	38	17	14.5	3.2
00681000	W-00681000	10	48	21.5	18.5	4.2
00681200	W-00681200	12	48	24	21	4.2
00681400	W-00681400	14	51.5	25.5	23	4.2
00681600	W-00681600	16	64	28	26	5.2

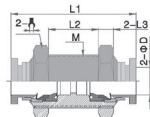

Unión Recta Pasamuros

Modelo (Negro)	Modelo (Blanco)	\varnothing D	M	L1	L2	L3	
00690400	W-00690400	4	M12*1.0	31	13	3.5	14
00690600	W-00690600	6	M14*1.0	33	13	4	17
00690800	W-00690800	8	M16*1.0	37.5	15	4.5	19
00691000	W-00691000	10	M18*1.0	42.5	18.5	5	21
00691200	W-00691200	12	M22*1.0	46.5	20	5	27

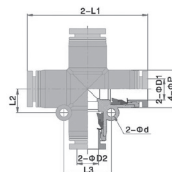

Conexión Cruz

Modelo (Negro)	Modelo (Blanco)	\varnothing D1	\varnothing D2	\varnothing P	L1	L2	L3	\varnothing d
00700400	W-00700400	4	4	11	37	7.5	15	3.2
00700600	W-00700600	6	6	13	38	8	16	3.2
00700800	W-00700800	8	8	14.5	45	9	18	3.2
00701000	W-00701000	10	10	18.5	56	11.5	23	4.2
00701200	W-00701200	12	12	21	58	13	26	4.2

CONEXIONES PLÁSTICAS

Métrico - Tubo \varnothing 4 a 16 mm D.E.

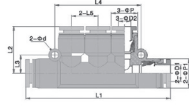

Conexión Triple Unión Reductor

Modelo	\varnothing D1	\varnothing D2	L1	L2	L3	L4	L5	\varnothing P1	\varnothing P2	\varnothing d
00710604	6	4	60	19	8	37.5	11	13	11	3.2
00710806	8	6	71	23	8.5	42	13	14.5	13	3.2
00711008	10	8	19.5	25	11	47.5	14.5	18.5	14.5	4.2

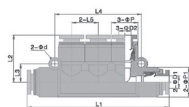

Conexión Triple Unión

Modelo (Negro)	\varnothing D1	\varnothing D2	L1	L2	L3	L4	L5	\varnothing P1	\varnothing P2	\varnothing d
00720400	4	4	59	19	8	37.5	11	13	11	3.2
00720600	6	6	69	23	8.5	42	13	14.5	13	3.2
00720800	8	8	78.5	25	11	47.5	14.5	18.5	14.5	4.2
00721000	10	10	91.5	29.5	12.5	60	18.5	21	18.5	4.2
00721200	12	12	100	29.5	13	68.5	21	21	21	4.2

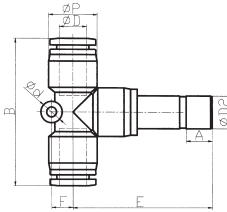

Conexión (T) Espiga Lisa Central

Modelo (Negro)	\varnothing D1	\varnothing D2	L1	L2	\varnothing P1	\varnothing P2	\varnothing d
00730604	6	4	34	15	13	11	3.2
00730804	8	4	36	16.5	14.5	13	3.2
00731006	8	6	36.5	16.5	14.5	13	3.2
00731008	10	6	43	19.5	18.5	14.5	3.2
00731208	10	8	43	19.5	18.5	14.5	3.2
00731210	12	6	47	23.5	21	18.5	4.2

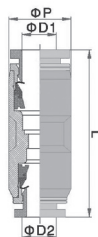

Unión Tubo Reductor

Modelo (Negro)	Modelo (Blanco)	\varnothing D1	\varnothing D2	L1	L2	\varnothing P1	\varnothing P2	\varnothing d
00740604	W-00740604	6	4	34	15	13	11	3.2
00740804	W-00740804	8	4	36	16.5	14.5	13	3.2
00740806	W-00740806	8	6	36.5	16.5	14.5	13	3.2
00741006	W-00741006	10	6	43	19.5	18.5	14.5	3.2
00741008	W-00741008	10	8	43	19.5	18.5	14.5	3.2
00741206	W-00741206	12	6	47	23.5	21	18.5	4.2
00741208	W-00741208	12	8	47	23.5	21	18.5	4.2
00741210	W-00741210	12	10	48	23.5	21	18.5	4.2
00741412	W-00741412	14	12	51	25	23	23	4.2
00741612	W-00741612	16	12	64	28	26	26	5.2
00741614	W-00741614	16	14	64.5	28	26	26	5.2

CONEXIONES PLÁSTICAS

Métrico - Tubo \varnothing 4 a 16 mm D.E.

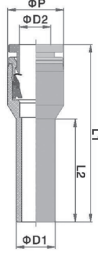

Adaptador de Reducción

Modelo (Negro)	Modelo (Blanco)	\varnothing D1	\varnothing D2	L1	L2	\varnothing P
00750604	W-00750604	6	4	38.5	22	11
00750804	W-00750804	8	4	40	25	11
00750806	W-00750806	8	6	41	25	13
00751006	W-00751006	10	6	41	26.5	13
00751008	W-00751008	10	8	45.5	26.5	14.5
00751208	W-00751208	12	8	43	26.5	14.5
00751210	W-00751210	12	10	51	26.5	18.5

(Y) Espiga Lisa Central Reductor

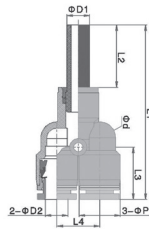

Modelo	\varnothing D1	\varnothing D2	L1	L2	L3	L4	\varnothing P	\varnothing d
00760604	6	4	49.5	19	14	11	11	3.2
00760804	-	-	-	-	-	-	-	-
00760806	8	6	61	62	18	14.5	14.5	4.2
00761006	-	-	-	-	-	-	-	-
00761008	10	8	67.5	23.5	20.5	18	18.5	4.2
00761208	-	-	-	-	-	-	-	-W
00761210	12	10	71	26.5	21	18	18.5	4.2

Conexión Tapón

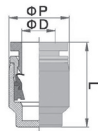

Modelo (Negro)	Modelo (Blanco)	\varnothing D	\varnothing P	L
00790400	W-00790400	4	11	18
00790600	W-00790600	6	13	19
00790800	W-00790800	8	14.5	21
00791000	W-00791000	10	18.5	23
00791200	W-00791200	12	21	25
00791600	W-00791600	16	26	27.5

CONEXIONES PLÁSTICAS - VÁLVULAS MANUALES/BOLA

Métrico - Tubo \varnothing 4 a 12 mm D.E.

Características - Válvulas manuales.

- Controla la apertura y cierre de la presión de aire en la línea.
- Al cerrar la válvula, la presión de aire residual en la salida se descarga automáticamente para proteger la tubería, con el fin de garantizar la seguridad durante el mantenimiento.
- Estas Válvulas son 3 vías 2 posiciones.

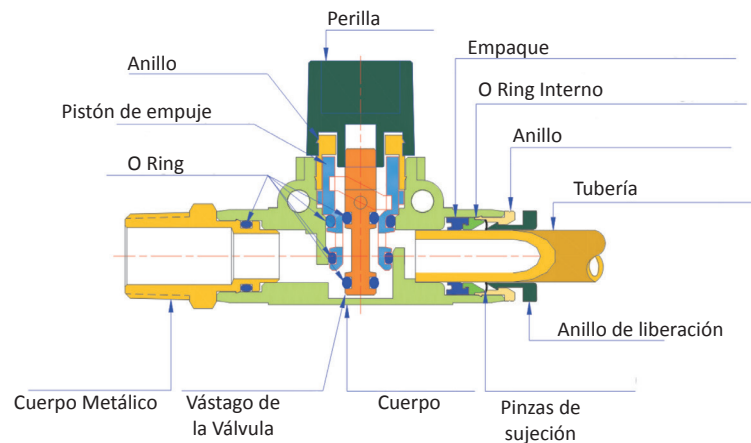
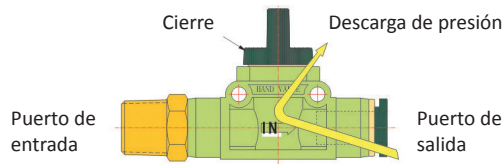

Características - Válvulas de Bola.

- Controla la apertura y cierre de la presión de aire en la línea.
- Estas Válvulas son 2 vías 2 posiciones.

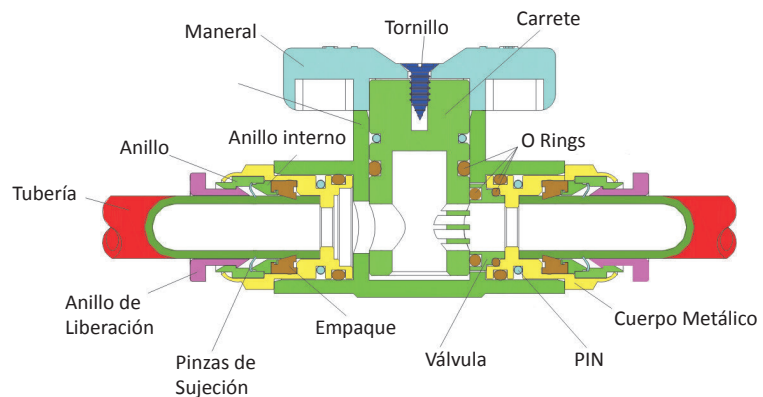

Especificaciones Técnicas.

Fluido	Aire, VAcío, Agua
Presión de trabajo	0 ~ 1.2 Mpa
Presión Negativa	750 mm Hg
Temperatura de trabajo	-10° ~ 60 °C
Tamaño de tubería	4, 6, 8, 10, 12, 14, 16 mm
Tamaño de Roscas	M5, R ¼, R ½, R ¾, R 1 ½

Materiales.

- Pistón de Empuje: POM
- Empaque: NBR
- O-Ring Interior: POM
- Anillo: ZINC
- Cuerpo: PBT
- Tubería: PU, PA, PE
- Anillo de liberación: POM
- Pinza de Sujeción: SUS
- Cuerpo Metálico: Latón Niquelado
- Vástago de Válvula: Latón Niquelado
- Tapa: POM
- Tornillo: SUS
- PIN: SUS
- Válvula: PPO
- Maneral: PPO
- Carrete: PPO
- O-Ring: NBR

CONEXIONES PLÁSTICAS - VÁLVULAS MANUALES/BOLA

Métrico - Tubo \varnothing 4 a 12 mm D.E.

Válvula Reguladora Tubo-tubo

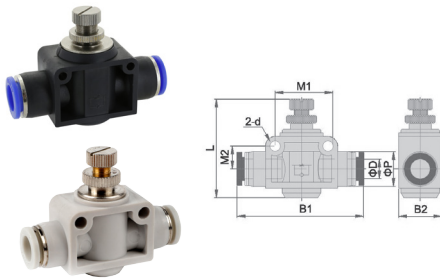

Modelo (Negro)	Modelo (Blanco)	\varnothing D	B1	B2	L		P	M1	M2	\varnothing d
					MIN	MAX				
00NSF0400	W-00NSF0400	4	40	11.5	27	29.5	11	14	6.5	3.2
00NSF0600	W-00NSF0600	6	47	15	39	44.5	13	20	8.5	4.2
00NSF0800	W-00NSF0800	8	52	18	42.5	47.5	14.5	22	9.5	4.2
00NSF1000	W-00NSF1000	10	63.5	21	46.5	52.5	18.5	26	11	4.2
00NSF1200	W-00NSF1200	12	74	28	54	59	21	32	14	4.2

Válvula Manual Tubo-tubo

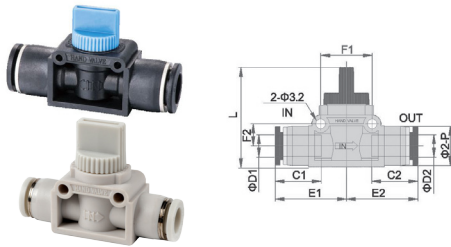

Modelo (Negro)	Modelo (Blanco)	\varnothing D1	\varnothing D2	L	E1	E2	P	C1	C2	F1	F2
00HVF0600	W-00HVF0600	6	6	37.5	26	26	14.5	16	16	18	8
00HVF0800	W-00HVF0800	8	8	37.5	27	27	14.5	18.5	18.5	18	8
00HVF1000	W-00HVF1000	10	10	40.5	35	35	21	20	20	24	11
00HVF1200	W-00HVF1200	12	12	40.5	34.5	34.5	21	23	23	24	11

Válvula Manual Macho-Macho (Cuerda R)

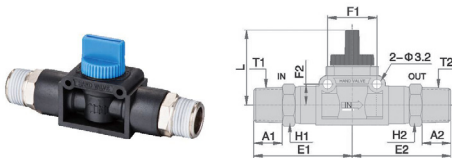

Modelo (Negro)	Modelo (Blanco)	T1	A1	T2	A2	L	E1	E2	F1	F2	H1	H2
01HVS1818	W-01HVS1818	R1/8	8	R1/8	8	37.5	34	34	18	8	12	12
01HVS2828	W-01HVS2828	R1/4	10	R1/4	10	37.5	36.5	36.5	18	8	14	14
01HVS3838	W-01HVS3838	R3/8	11	3/8	11	40.5	45	45	24	11	17	17
01HVS4848	W-01HVS4848	R1/2	14	1/2	14	40.5	48.5	48.5	24	11	21	21

Válvula de Bola Tubo-tubo

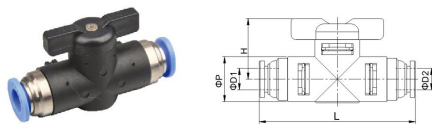

Modelo	\varnothing D1	\varnothing D2	\varnothing P	L	H
00BVU0600	6	8	17	52	23
00BVU0600	8	6	17	58	23
00BVU0806	8	6	17	55	23

Válvula de Bola Cuerda-tubo

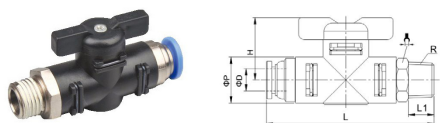

Modelo	\varnothing D	R	\varnothing P	L	L1	H	
00BVC0618	6	R1/8	17	56	7.5	23	17
00BVC0628	6	R1/4	17	58	9.5	23	17
00BVC0638	6	R3/8	17	59	10.5	23	17
00BVC0818	8	R1/8	17	59	7.5	23	17
00BVC0828	8	R1/4	17	61	9.5	23	17
00BVC0838	8	R3/8	17	62	10.5	23	17

CONEXIONES PLÁSTICAS CON FUNCIÓN DE CIERRE

Métrico - Tubo \varnothing 4 a 12 mm D.E.

Características.

- Este tipo de conectores también se conocen como “Stop Fittings”.
- Conexión rápida con válvula de cierre.
- Debido a la función de cierre, el aire únicamente circula cuando la tubería se encuentra conectada al conector.

Figura.

Simbolo gráfico

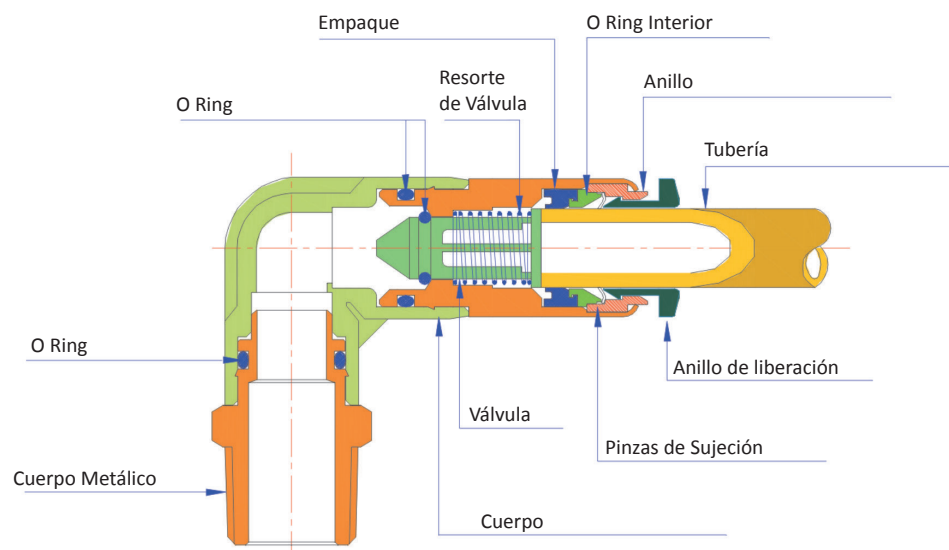
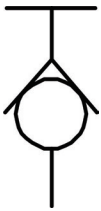

Materiales.

- Cuerpo Metálico: Latón Niquelado
- O-Ring: NBR
- Cuerpo: PBT
- Empaque: NBR
- O-Ring Interior: POM
- Anillo: ZINC
- Tubería: PU, PA, PE
- Anillo de liberación: POM
- Pinza de Sujeción: SUS
- Válvula
- Resorte de Válvula

Especificaciones Técnicas.

Fluido	Aire, VAcío, Agua
Presión de trabajo	0 ~ 1.2 Mpa
Presión Negativa	750 mm Hg
Temperatura de trabajo	-10° ~ 60 °C
Tamaño de tubería	4, 6, 8, 10, 12 mm
Tamaño de Roscas	M5, R 1/8, R 1/4, R 3/8, R 1/2

CONEXIONES PLÁSTICAS CON FUNCIÓN DE CIERRE

Métrico - Tubo \varnothing 4 a 12 mm D.E.

Válvula Recta Macho Hexagonal (Cuerda R)

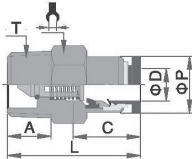

Modelo	\varnothing D	T	A	L	P	C	
312104M5	4	M5X0.8	3.5	32	10	15	10
31210418	4	R1/8	8	24.8	10	15	10
31210428	4	R1/4	10	24.8	10	15	14
31210618	6	R1/8	8	25	10	16	12
31210628	6	R1/4	10	27	10	16	14
31210828	8	R1/4	10	33.5	14	18.5	14
31210838	8	R3/8	11	33.5	14	18.5	17
31211028	10	R1/4	10	36	17	20	17
31211038	10	R3/8	11	36	17	20	17
31211048	10	R1/2	14	37	17	20	21
31211238	12	R3/8	11	37	20.5	23	21
31211248	12	R1/2	14	37	20.5	23	21

Válvula Codo Macho (Cuerda R)

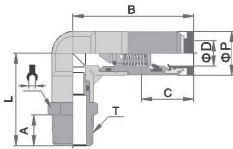

Modelo	\varnothing D	T	A	L	B	P	C	
312204M5	4	M5X0.8	3.5	26.5	36.5	10.5	15	10
31220418	4	R1/8	8	30	36.5	10.5	15	10
312206M5	6	M5X0.8	3.5	28	37	13	16	12
31220618	6	R1/8	8	31.5	37	13	16	12
31220628	6	R1/4	10	34	37	13	16	14
31220818	8	R1/8	8	35	45.5	14	18.5	14
31220828	8	R1/4	10	37	45.5	14	18.5	14
31221028	10	R1/4	10	44	53	18	20	17
31221038	10	R3/8	11	45	53	18	20	17
31221048	10	R1/2	14	48	53	18	20	21
31221238	12	R3/8	11	47.5	56.5	20.5	23	17
31221248	12	R1/2	14	51	56.5	20.5	23	21

Válvula Unión Tubo-tubo

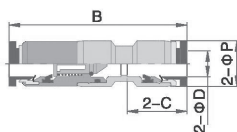

Modelo	\varnothing D	B	P	C
30680400	4	45.5	10.5	15
30680600	6	47.5	13	16
30680800	8	54.5	14	18.5
30681000	10	64.5	18	20
30681200	12	66	20.5	23

CONEXIONES PLÁSTICAS CON FUNCIÓN ANTIRETORNO

Métrico - Tubo \varnothing 4 a 12 mm D.E.

Características.

- Este tipo de conectores también se conocen como “Check Fittings”.
- El flujo de aire será únicamente en una dirección por lo que en dirección opuesta el aire o fluido no circulará.
- Garantiza una salida de presión estable.

Figura.

Simbolo gráfico

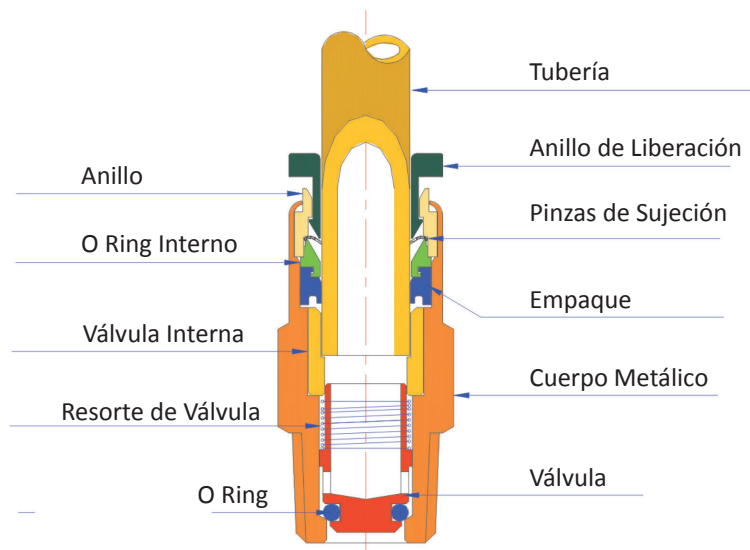
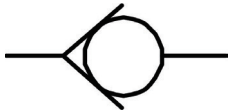

Materiales.

- Cuerpo Metálico: Latón Niquelado
- O-Ring: NBR
- Cuerpo: PBT
- Empaque: NBR
- O-Ring Interior: POM
- Anillo: ZINC
- Tubería: PU, PA, PE
- Anillo de liberación: POM
- Pinza de Sujeción: SUS
- Válvula Interna: Latón Niquelado
- Resorte de Válvula
- Válvula

Especificaciones Técnicas.

Fluido	Aire, VAcío, Agua
Presión de trabajo	0 ~ 1.2 Mpa
Presión Negativa	750 mm Hg
Temperatura de trabajo	-10° ~ 60 °C
Tamaño de tubería	4, 6, 8, 10, 12 mm
Tamaño de Roscas	M5, R 1/8, R 1/4, R 3/8, R 1/2

CONEXIONES PLÁSTICAS CON FUNCIÓN ANTIRETORNO

Métrico - Tubo ϕ 4 a 12 mm D.E.

Válvula Check Recta Macho (Cuerda R)

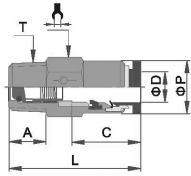

Modelo	ϕ D	T	A	L	P	C	
412104M5	4	M5X0.8	3.5	33	10	15	10
41210418	4	R1/8	8	28	10	15	10
41210618	6	R1/8	8	30	12	16	12
41210628	6	R1/4	10	30	12	16	14
41210818	8	R1/8	8	35	14	18.5	14
41210828	8	R1/4	10	35	14	18.5	14
41211038	10	R3/8	11	44	17	20	17
41211048	10	R1/2	14	44	17	20	21
41211238	12	R3/8	11	42.5	20.5	23	21
41211248	12	R1/2	14	42.5	20.5	23	21

Válvula Check Macho-Hembra (Cuerda R)

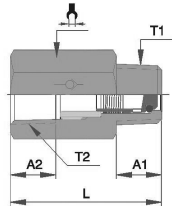

Modelo	T1/T2	A1/A2	L	
41391818	R1/8	8	26.5	12
41392828	R1/4	10	33.5	17
41393838	R3/8	11	38	20
41394848	R1/2	14	42.5	24

Válvula Check Hembra - Hembra (Cuerda R)

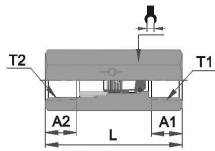

Modelo	T1/T2	A1/A2	L	
41401818	R1/8	8	35	12
41402828	R1/4	10	44.5	17
41403838	R3/8	11	50	20
41404848	R1/2	14	56.5	24

Válvula Check Unión Tubo-tubo

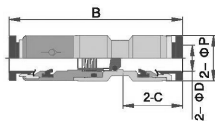

Modelo	ϕ D	B	P	C
40680400	4	45	10.5	15
40680600	6	47.5	13	16
40680800	8	54	14	18.5
40681000	10	64	18	20
40681200	12	64	20.5	23

CONEXIONES PLÁSTICAS MINI

Métrico - Tubo $\varnothing 3$, $\varnothing 4$, $\varnothing 6$ D.E.

Características.

- Conectores rápidos ultra- pequeños para uso neumático.
- 40% de los conectores más usuales se han miniaturizado con éxito.
- Cuerpo de latón niquelado ayuda a evitar la corrosión.

Comparativo



Figura.



Materiales.

- Cuerpo Metálico: Latón Niquelado
- O-Ring: NBR
- Cuerpo: PBT
- Empaque: NBR
- O-Ring Interior: POM
- Anillo: ZINC
- Tubería: PU, PA, PE
- Anillo de liberación: POM
- Pinza de Sujeción: SUS

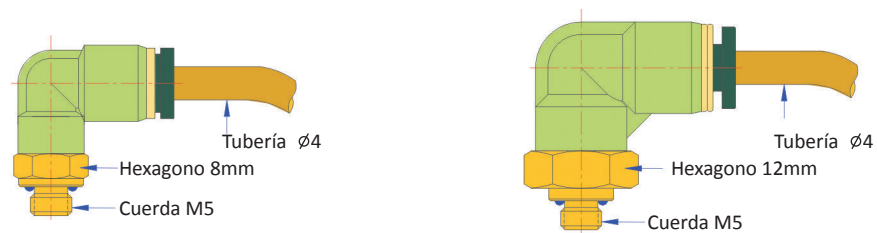
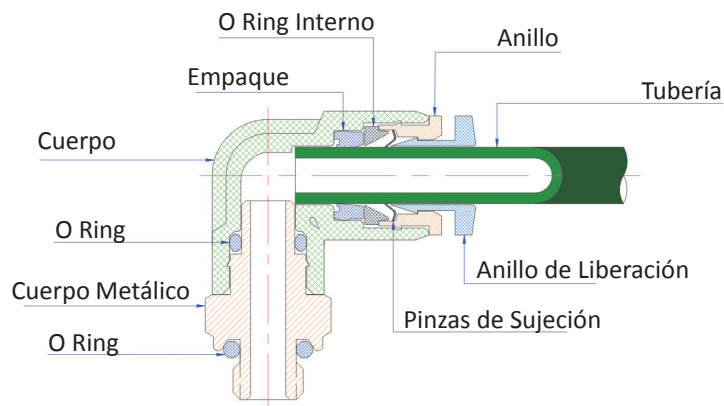
Especificaciones Técnicas.

Fluido	Aire, VAcío, Agua
Presión de trabajo	0 ~ 1.2 Mpa
Presión Negativa	750 mm Hg
Temperatura de trabajo	-10° ~ 60 °C
Tamaño de tubería	3, 4, 6 mm
Tamaño de Roscas	M3, M5, M6, R ½

CONEXIONES PLÁSTICAS MINI

Métrico - Tubo $\phi 3$, $\phi 4$, $\phi 6$ D.E.

Conexión Recta Macho (Mini)

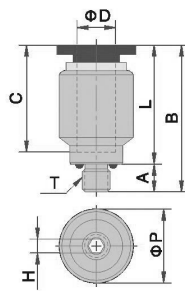

Modelo	ϕD	T	A	B	L	P	C	H
MI-012003M3	3	M3X0.5	3	15.5	12.5	8	9.5	1.5
MI-012003M5	3	M5X0.8	3.5	16	12.5	8	9.5	2
MI-012003M6	3	M6X1.0	4	16.5	12.5	8	9.5	2
MI-012004M3	4	M3X0.5	3	16	13	8	11	1.5
MI-012004M5	4	M5X0.8	3.5	17	13.5	8	11	2.5
MI-012004M6	4	M6X1.0	4	17.5	13.5	8	11	3
MI-01200418	4	R1/8	7.5	18	14	10	11	3
MI-012006M5	6	M5X0.8	3.5	17.5	14	10	11.5	2.5
MI-012006M6	6	M6X1.0	4	18	14	10	11.5	3
MI-01200618	6	R1/8	7.5	18	14	10	11.5	4

Conexión Recta Macho Hexagonal (Mini)

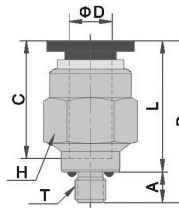

Modelo	ϕD	T	A	B	L	C	H
MI-012103M3	3	M3X0.5	3	15.5	12.5	9.5	8
MI-012103M5	3	M5X0.8	3.5	16	12.5	9.5	8
MI-012103M6	3	M6X1.0	4	16.5	12.5	9.5	8
MI-012104M3	4	M3X0.5	3	16	13	11	8
MI-012104M5	4	M5X0.8	3.5	17	13.5	11	8
MI-012104M6	4	M6X1.0	4	17.5	13.5	11	8
MI-01210418	4	R1/8	7	18	14	11	10
MI-012106M5	6	M5X0.8	3	17.5	14	11.5	10
MI-012106M6	6	M6X1.0	3.5	18	14	11.5	10
MI-01210618	6	R1/8	4	18	14	11.5	10

Conexión Codo Macho (Mini)

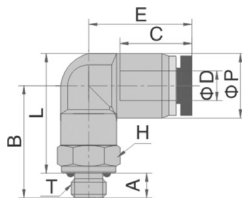

Modelo	ϕD	T	A	E	B	L	P	C	H
MI-012203M3	3	M3X0.5	3	12	15.5	16	7	9.5	8
MI-012203M5	3	M5X0.8	3.5	12	16	16	7	9.5	8
MI-012203M6	3	M6X1.0	4	12	16.5	16	7	9.5	8
MI-012204M3	4	M3X0.5	3	14.5	15.5	17	9	11	8
MI-012204M5	4	M5X0.8	3.5	14.5	16	17	9	11	8
MI-012204M6	4	M6X1.0	4	14.5	16.5	17	9	11	8
MI-01220418	4	R1/8	7.5	14.5	19.5	20	9	11	10
MI-012206M5	6	M5X0.8	3.5	16.5	16	18	11	11.5	8
MI-012206M6	6	M6X1.0	4	16.5	16.5	18	11	11.5	8
MI-01220618	6	R1/8	7.5	16.5	19.5	21	11	11.5	10

CONEXIONES PLÁSTICAS MINI

Métrico - Tubo $\phi 3$, $\phi 4$, $\phi 6$ D.E.

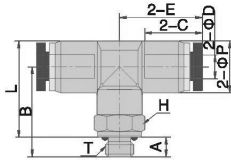

Conexión (T) Orientable Tubo-Rosca Macho Central (Mini)

Modelo	ϕD	T	A	E	B	L	P	C	H
MI-012503M3	3	M3X0.5	3	12	15.5	16	7	9.5	8
MI-012503M5	3	M5X0.8	3.5	12	16	16	7	9.5	8
MI-012503M6	3	M6X1.0	4	12	16.5	16	7	9.5	8
MI-012504M3	4	M3X0.5	3	14.5	15.5	17	9	11	8
MI-012504M5	4	M5X0.8	3.5	14.5	16	17	9	11	8
MI-012504M6	4	M6X1.0	4	14.5	16.5	17	9	11	8
MI-01250418	4	R1/8	7.5	14.5	19.5	20	9	11	10
MI-012506M5	6	M5X0.8	3.5	16.5	16	18	11	11.5	8
MI-012506M6	6	M6X1.0	4	16.5	16.5	18	11	11.5	8
MI-01250618	6	R1/8	7.5	16.5	19.5	21	11	11.5	10

Conexión (Y) Orientable Rosca Macho (Mini)

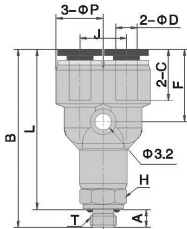

Modelo	$\phi D1$	T	A	F	J	B	L	P	C	H
MI-012603M3	3	M3X0.5	3	12	7	31.5	28.5	7	9.5	8
MI-012603M5	3	M3X0.8	3.5	12	7	32	28.5	7	9.5	8
MI-012603M6	3	M3X1.0	4	12	7	32.5	28.5	7	9.5	8
MI-012604M3	4	M3X0.5	3	14	9	34	31	9	11	8
MI-012604M5	4	M3X0.8	3.5	14	9	34.5	31	9	11	8
MI-012604M6	4	M3X1.0	4	14	9	35	31	9	11	8
MI-01260418	4	R1/8	7.5	14	9	37.5	33.5	9	11	10
MI-012606M5	6	M3X0.8	3.5	15	11	37	33.5	11	11.5	8
MI-012606M6	6	M3X1.0	4	15	11	37.5	33.5	11	11.5	8
MI-01260618	6	R1/8	7.5	15	11	40	36	11	11.5	10

Conexión Recta Hembra (Mini)

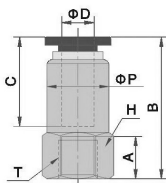

Modelo	ϕD	T	A	B	P	C	H
MI-013004M3	3	M3X0.5	4	16	8	9.5	8
MI-013004M5	3	M5X0.8	5	17.5	8	9.5	8
MI-013004M6	3	M6X1.0	5	17.5	8	9.5	8
MI-013004M3	4	M3X0.5	4	17.5	8	11	8
MI-013004M5	4	M5X0.8	5	19	8	11	8
MI-013004M6	4	M6X1.0	5	19	8	11	8
MI-01300418	4	R1/8	7.5	22	8	11	12
MI-013006M5	6	M5X0.8	5	19	10	11.5	10
MI-013006M6	6	M6X1.0	5	19	10	11.5	10
MI-01300618	6	R1/8	7.5	22	10	11.5	12

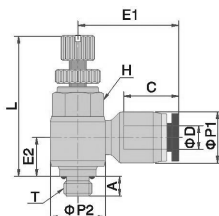

Banjo Regulador de Caudal (Mini)

Modelo	ϕD	T	A	L		P1	P2	C	E1	E2	H
				max	min						
MI-013103M5	3	M3X0.5	3	26	25.5	9	9.5	11	18	7	8
MI-013104M5	4	M5X0.8	3.5	28	25.5	9	9.5	11	18	7	8
MI-013106M6	6	M6X1.0	4	28.5	26	9	9.5	11	18	7	8

CONEXIONES PLÁSTICAS MINI

Métrico - Tubo $\varnothing 3$, $\varnothing 4$, $\varnothing 6$ D.E.

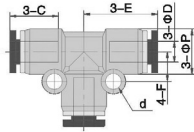

(T) Unión Tubos (Mini)

Modelo	$\varnothing D1$	E	P	C	F	d
MI-00620300	3	12	7	9.5	5	3.2
MI-00620400	4	14.5	9	11	6	3.2
MI-00620600	6	16.5	11	11.5	6.5	3.2

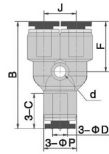

(Y) Unión Tubos (Mini)

Modelo	$\varnothing D$	B	P	C	F	J	d
MI-00640300	3	27	7	9	12	7	3.2
MI-00640400	4	30	9.5	11	14	9	3.2
MI-00640600	6	33	11	11.5	15	11	3.2

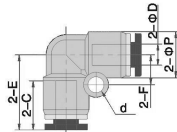

Codo Tubo-tubo (Mini)

Modelo	$\varnothing D1$	E	P	C	F	d
MI-00660300	3	12	7	9.5	5	3.2
MI-00660400	4	14.5	9	11	6	3.2
MI-00660600	6	16.5	11	11.5	6.5	3.2

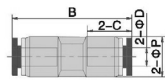

Unión Tubo-tubo (Mini)

Modelo	$\varnothing D$	B	P	C
MI-00680300	3	23.5	7	9.5
MI-00680400	4	27.5	9	11
MI-00680600	6	28	11	11.5

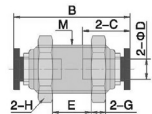

Unión Recta Pasamuros (Mini)

Modelo	$\varnothing D1$	M	B	E	C	G	H
MI-00690300	3	M8X0.75	20.5	6	9.5	2.5	10
MI-00690400	4	M10X1.0	23	8	11	3	12
MI-00690600	6	M12X1.0	24	9	11.5	3.5	14

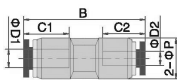

Unión Tubo-tubo Reductor (Mini)

Modelo	$\varnothing D1$	$\varnothing D2$	B	P	C1	C2
MI-00740304	4	3	27.5	9	11	9.5
MI-00740604	6	4	11	11.5	11.5	11

CONEXIONES METÁLICAS

Métrico - Tubo $\varnothing 4$ a 12 mm D.E.

Características.

- Estos conectores están fabricados en Latón Niquelado.
- Tienen una excelente resistencia la fuego, a las altas temperaturas y al agua.
- Presionar el anillo de liberación al insertar o remover la tubería para evitar dañar la misma.

Figura.

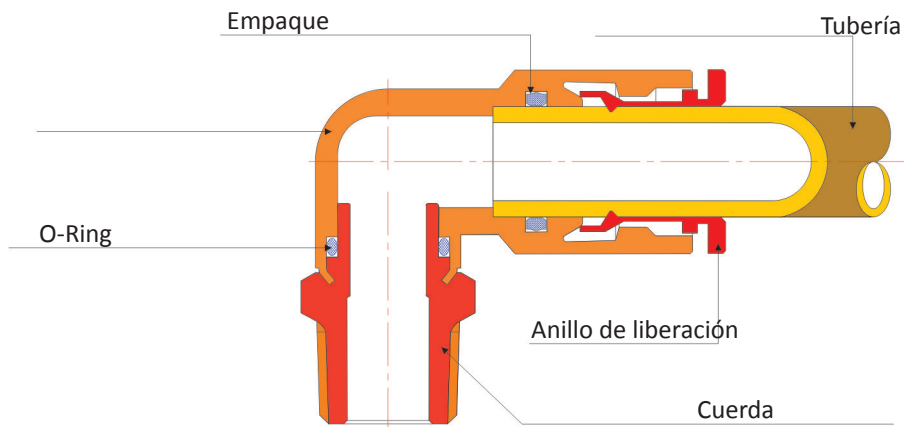

Materiales.

- Cuerpo Metálico: Latón Niquelado
- O-Ring: FKM
- Empaque: FKM
- Tubería: PU, PA, PE
- Anillo de liberación: Latón Niquelado
- Cuerda: Latón Niquelado

Especificaciones Técnicas.

Fluido	Aire, VAcío, Agua
Presión de trabajo	0 ~ 1.8 Mpa
Presión Negativa	750 mm Hg
Temperatura de trabajo	-20° ~ 80 °C
Tamaño de tubería	4, 6, 8, 10, 12 mm
Tamaño de Roscas	M5, R 1/8, R 1/4, R 3/8, R 1/2

CONEXIONES METÁLICAS

Métrico - Tubo $\varnothing 4$ a 12 mm D.E.

Conexión Recta Macho (Cuerda R)

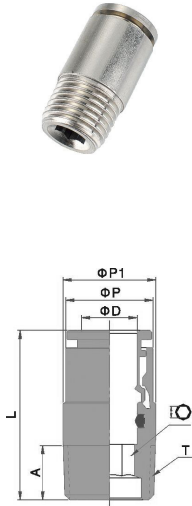

Modelo	ϕD	T	A	L	$\phi P1$	$\phi P2$	ϕI
1121A04M5	4	M5X0.8	3.5	23.5	10	10	2
1121A0418	4	R1/8	8	23	10	10	3
1121A0428	4	R1/4	10	23	13.4	10	3
1121A06M5	6	M5X0.8	3.5	24.2	12	12	2
1121A0618	6	R1/8	8	24.5	12	12	5
1121A0628	6	R1/4	10	24.7	13.4	12	5
1121A0638	6	R3/8	-	-	13.4	12	5
1121A0648	6	R1/2	-	-	13.4	12	5
1121A0818	8	R1/8	8	28.2	14	14	5
1121A0828	8	R1/4	10	27.2	14	14	6
1121A0838	8	R3/8	11	27.2	17	14	6
1121A0848	8	R1/2	14	27.2	21	14	6
1121A1018	10	R1/8	8	30.7	16	16	5
1121A1028	10	R1/4	10	31.2	16	16	6
1121A1038	10	R3/8	11	31.2	17	16	8
1121A1048	10	R1/2	14	31.2	21	16	8
1121A1228	12	R1/4	10	33.2	18	18	6
1121A1238	12	R3/8	11	32.2	18	18	8
1121A1248	12	R1/2	14	31.7	21	18	8

Conexión Recta Macho Hexagonal (Cuerda R)

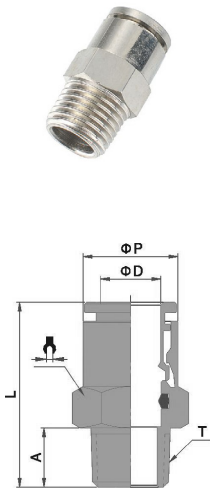



Modelo	ϕD	T	A	L	ϕP	ϕI
112104M5	4	M5X0.8	3.5	23.5	10	10
11210418	4	R1/8	8	23	10	10
11210428	4	R1/4	10	23.5	10	14
112106M5	6	M5X0.8	3.5	24.2	12	12
11210618	6	R1/8	8	24.5	12	12
11210628	6	R1/4	10	24.7	12	14
11210638	6	R3/8	-	-	12	14
11210648	6	R1/2	-	-	12	14
11210818	8	R1/8	8	28.2	14	14
11210828	8	R1/4	10	27.2	14	14
11210838	8	R3/8	11	27.2	14	17
11210848	8	R1/2	14	27.2	14	21
11211018	10	R1/8	8	30.7	16	17
11211028	10	R1/4	10	31.2	16	17
11211038	10	R3/8	11	31.2	16	17
11211048	10	R1/2	14	31.2	16	21
11211228	12	R1/4	10	33.2	18	19
11211238	12	R3/8	11	32.2	18	19
11211248	12	R1/2	14	31.7	18	21

CONEXIONES METÁLICAS

Métrico - Tubo $\phi 4$ a 12 mm D.E.

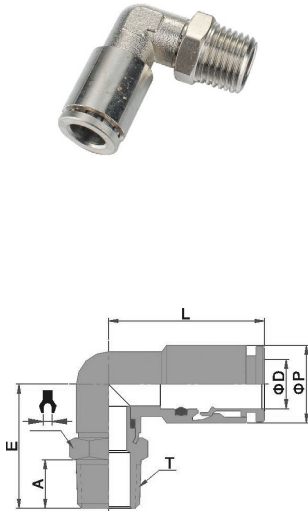
Conexión Codo Macho (Cuerda R)



Modelo	ϕD	T	A	L	E	ϕP	
112204M5	4	M5X0.8	3.5	23.5	15.8	10	8
11220418	4	R1/8	8	-	19.3	-	10
11220428	4	R1/4	10	-	21.8	-	14
112206M5	6	M5X0.8	3.5	24.7	16.8	12	10
11220618	6	R1/8	8	-	20.4	-	-
11220628	6	R1/4	10	-	22.9	-	14
11220638	6	R3/8	-	-	-	-	-
11220648	6	R1/2	-	-	-	-	-
11220818	8	R1/8	8	27.2	22.5	14	12
11220828	8	R1/4	10	-	24.5	-	14
11220838	8	R3/8	11	-	25.5	-	17
11220848	8	R1/2	14	-	29	-	21
11221018	10	R1/8	8	31.7	23.5	16	14
11221028	10	R1/4	10	-	25.5	-	-
11221038	10	R3/8	11	-	26.5	-	17
11221048	10	R1/2	14	-	30	-	21
11221228	12	R1/4	10	32.2	26.7	18	17
11221238	12	R3/8	11	-	27.7	-	-
11221248	12	R1/2	14	-	31.2	-	21

Conexión (T) Orientable Tubo-Rosca Macho Central (Cuerda R)

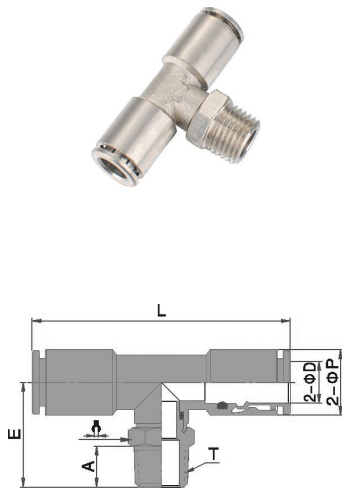

Modelo	ϕD	T	A	L	E	ϕP	
112504M5	4	M5X0.8	3.5	47	15.8	10	8
11250418	4	1/8	8	47	19.3	10	10
11250428	4	1/4	10	47	21.8	10	14
112506M5	6	M5X0.8	3.5	49.5	16.8	12	10
11250618	6	1/8	8	49.5	20.4	12	10
11250638	6	1/4	10	49.5	22.9	12	14
11250648	6	3/8	-	49.5	-	12	14
11250638	6	1/2	-	49.5	-	12	14
11250818	8	1/8	8	55.4	22.5	14	12
11250828	8	1/4	10	55.4	24.5	14	14
11250838	8	3/8	11	55.4	25.5	14	17
11250848	8	1/2	14	55.4	29	14	21
11251018	10	1/8	8	63.4	23.5	16	14
11251028	10	1/4	10	63.4	25.5	16	14
11251038	10	3/8	11	63.4	26.5	16	17
11251048	10	1/2	14	63.4	30	16	21
11251228	12	1/4	10	64.4	26.7	18	17
11251238	12	3/8	11	64.4	27.7	18	17
11251248	12	1/2	14	64.4	31.2	18	21

CONEXIONES METÁLICAS

Métrico - Tubo $\varnothing 4$ a 12 mm D.E.

Banjo (Cuerda R)

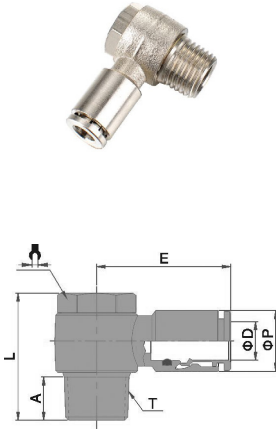

Modelo	$\varnothing D$	T	A	L	E	$\varnothing P$	
112704M5	4	M5X0.8	3.5	17	23.5	10	8
11270418	4	R1/8	8	24	24	10	12
11270428	4	R1/4	10	26.5	26	10	14
112706M5	6	M5X0.8	3.5	17	23.5	12	8
11270618	6	R1/8	8	24	24	12	12
11270628	6	R1/4	10	26.5	26	12	14
11270638	-	-	-	-	-	-	-
11270648	-	-	-	-	-	-	-
11270818	8	R1/8	8	24	25.5	14	12
11270828	8	R1/4	10	26.5	27.5	14	14
11270838	8	R3/8	11	32	29.5	14	19
11270848	8	R1/2	14	39	34.7	14	24
11271018	-	-	-	-	-	-	-
11271028	10	R1/4	10	26.5	31.2	16	14
11271038	10	R3/8	11	32	32	16	19
11271048	10	R1/2	14	39	36.2	16	24
11271228	-	-	-	-	-	-	-
11271238	-	-	-	-	-	-	-
11271248	-	-	-	-	-	-	-

Conexión Recta Hembra (Cuerda R)

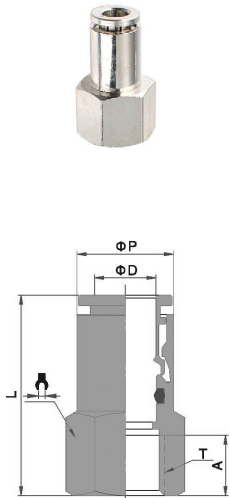



Modelo	$\varnothing D$	T	A	L	$\varnothing P$	
113004M5	4	M5X0.8	5	24.5	10	10
11300418	4	R01	8	27.5	10	14
11300428	4	R02	10	30	10	17
113006M5	6	M5X0.8	5	24.7	12	12
11300618	6	R01	8	28.2	12	14
11300628	6	R02	10	30.7	12	17
11300638	6	R03	-	-	12	17
11300648	6	R04	-	-	12	17
11300818	8	R01	8	28.7	14	14
11300828	8	R02	10	31.5	14	17
11300838	8	R03	11	32.5	14	20
11300848	8	R04	14	34.5	14	24
11301018	10	R01	8	29.7	16	17
11301028	10	R02	10	33.2	16	17
11301038	10	R03	11	34.2	16	20
11301048	10	R04	14	36.2	16	24
11301228	12	R02	10	33.7	18	19
11301238	12	R03	11	34.7	18	20
11301248	12	R04	14	36.7	18	24

CONEXIONES METÁLICAS

Métrico - Tubo $\varnothing 4$ a 12 mm D.E.

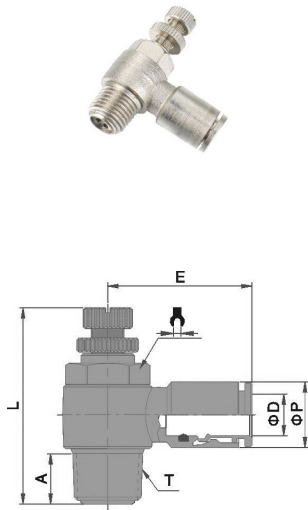
Banjo Regulador de Caudal (Cuerda R)



Modelo	$\varnothing D$	T	A	L-MIN	L-MAX	E	$\varnothing P$	
113104M5	4	M5X0.8	3.5	29	31.5	23.5	10	8
11310418	4	1/8	8	35	40.5	24	10	12
11310428	4	1/4	10	41.5	47	26	10	14
113106M5	6	M5X0.8	3.5	29	31.5	24.2	12	8
11310618	6	R1/8	8	35	40.5	24	12	12
11310628	6	R1/4	10	41.5	47	26	12	14
11310638	6	-	-	-	-	-	12	14
11310648	6	-	-	-	-	-	12	14
11310818	8	R1/8	8	35	40.5	25.5	14	12
11310828	8	R1/4	10	41.5	47	27.5	14	14
11310838	8	R3/8	11	48	53.5	29.5	14	19
11310848	8	R1/2	14	53.5	59.5	34.7	14	24
11311018	10	R1/8	10	41.5	47	31.2	16	14
11311028	10	R1/4	11	48	53.5	32	16	19
11311038	10	R3/8	14	53.5	59.5	36.2	16	24
11311048	10	R1/2	-	-	-	-	-	-
11311228	12	R1/4	-	-	-	-	-	-
11311238	12	R3/8	-	-	-	-	-	-
11311248	12	R1/2	-	-	-	-	-	-

(T) Unión Tubos

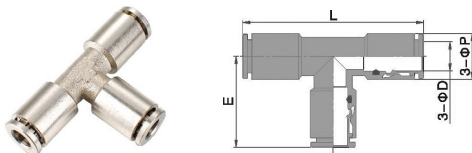

Modelo	$\varnothing D$	L	E	$\varnothing P$
10620400	4	47	23.5	10
10620600	6	49.4	24.7	12
10620800	8	55.4	27.7	14
10621000	10	63.4	31.7	16
10621200	12	64.4	32.2	18

(Y) Unión Tubos



Modelo	$\varnothing D$	L	E	$\varnothing P$
10640400	4	-	-	-
10640600	6	-	-	-
10640800	8	-	-	-
10641000	10	-	-	-
10641200	12	-	-	-

CONEXIONES METÁLICAS

Métrico - Tubo $\varnothing 4$ a 12 mm D.E.

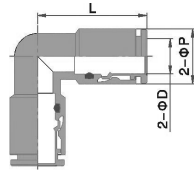

Codo Tubo-tubo

Modelo	$\varnothing D$	L	$\varnothing P$
10660400	4	23.5	10
10660600	6	24.7	12
10660800	8	27.7	14
10661000	10	31.7	16
10661200	12	32.2	18

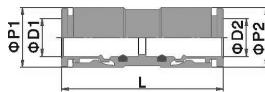

Unión Tubo-tubo

Modelo	$\varnothing D1$	$\varnothing D2$	L	$\varnothing P1$	$\varnothing P2$
10680400	4		37.6	10	
10680600	6		38.4	12	
10680800	8		40.4	14	
10681000	10		44	16	
10681200	12		45	18	

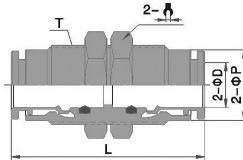

Unión Recta Pasamuros

Modelo	$\varnothing D$	T	L	$\varnothing P$	
10690400	4	M12X1.0	37.6	10	14
10690600	6	M14X1.0	38.4	12	17
10690800	8	M16X1.0	40.4	14	19
10691000	10	M18X1.0	44	16	21
10691200	12	M20X1.0	45	18	24

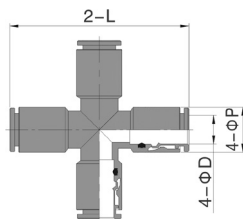

Conexión Cruz

Modelo	$\varnothing D$	L	$\varnothing P$
10700400	4	47	10
10700600	6	49.4	12
10700800	8	55.4	14
10701000	10	63.4	16
10701200	12	64.4	18

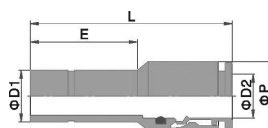

Conexión Unión Tubo Reductor

Modelo	$\varnothing D1$	$\varnothing D2$	L	$\varnothing P$	E
10750604	6	4	35	10	21
10750806	8	6	36	12	22
10751008	10	8	41	14	23
10751208	12	10	44	16	25
10751210	-	-	-	-	-

CONEXIONES EN ACERO INOXIDABLE

Métrico - Tubo \varnothing 4 a 12 mm D.E.

Características.

- Todas las piezas están fabricadas en acero inoxidable 316L, excepto los empaques. Estos conectores tienen una alta resistencia a la corrosión.
- Los empaques están fabricados en FKM (viton), el cuál tiene una alta resistencia química, resistente a los acidos y las altas temperaturas.
- Todos los componentes son libres de aceite y cumplen con las normas de la industria alimenticia, son utilizadas principalmente para la industria alimenticia, química, medica entre otras.

Figura.

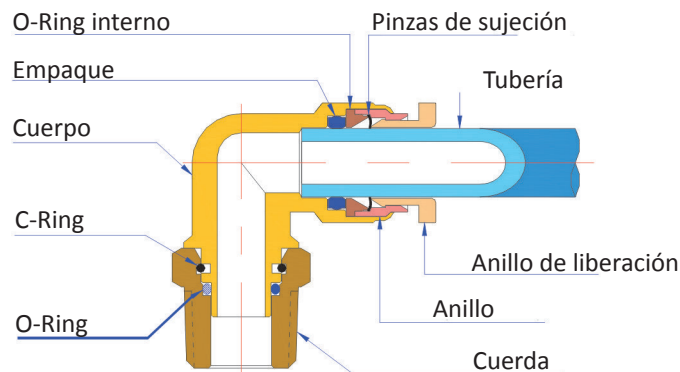

Materiales.

- Cuerpo: SUS 316L
- O-Ring: FKM
- Empaque: FKM
- O-Ring Interno: SUS 316L
- Anillo: SUS 316L
- Tubería: PU, PA, PE
- Anillo de liberación: SUS 316L
- Pinsas de sujeción: SUS 316L
- Cuerda: SUS 316L

Especificaciones Técnicas.

Fluido	Aire, Agua, Vapor
Presión de trabajo	0 ~ 2 Mpa
Presión Negativa	750 mm Hg
Temperatura de trabajo	-20° ~ 140 °C
Tamaño de tubería	4, 6, 8, 10, 12 mm
Tamaño de Roscas	M5, R 1/8, R 1/4, R 3/8, R 1/2

CONEXIONES EN ACERO INOXIDABLE

Métrico - Tubo $\phi 4$ a 12 mm D.E.

Conexión Recta Macho Hexagonal (Cuerda R)

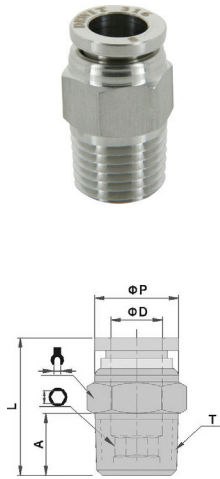

Modelo	ϕD	T	A	L	ϕP		
212104M5	4	M5x0.8	4	19.5	10	10	-
21210418	4	R1/8	7.5	18.5	10	10	3
21210428	4	R1/4			10	10	
212106M5	6	M5x0.8	3.5	20.3	12	12	-
21210618	6	R1/8	7.5	19.8	12	12	4
21210628	6	R1/4	10	21.3	12	14	4
21210638	6	R3/8			12	14	
21210648	6	R1/2			12	14	
21210818	8	R1/8	7.5	24.4	14	14	5
21210828	8	R1/4	10	22.1	14	14	6
21210838	8	R3/8			14	14	
21210848	8	R1/2			14	14	
21211018	10	R1/8			14	14	
21211028	10	R1/4	10	28	17	17	6
21211038	10	R3/8	11	24.5	17	17	8
21211048	10	R1/2	14	28	17	21	8
21211228	12	R1/4	10	31.4	20	20	6
21211238	12	R3/8	11	28.9	20	20	8
21211248	12	R1/2	14	28.4	20	21	10

Conexión Codo Macho (Cuerda R)

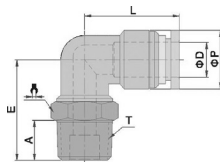



Modelo	ϕD	T	A	L	E	ϕP	
212204M5	4	M5X0.8	4	18.3	20.5	10	10
21220418	4	R1/8	7.5	18.3	19.3	10	10
21220428	-	-	-	-	-	-	-
212206M5	6	M5X0.8	3.5	20.1	21.5	12	10
21220618	6	R1/8	7.5	20.1	20.3	12	12
21220628	6	R1/4	10	20.1	22.8	12	14
21220638	-	-	-	-	-	-	-
21220648	-	-	-	-	-	-	-
21220818	8	R1/8	7.5	22.8	23.5	14	14
21220828	8	R1/4	10	22.8	24	14	14
21220838	-	-	-	-	-	-	-
21220848	-	-	-	-	-	-	-
21221018	-	-	-	-	-	-	-
21221028	10	R1/4	10	26.7	28.3	17	17
21221038	10	R3/8	11	26.7	28.8	17	17
21221048	10	R1/2	14	26.7	31.8	17	21
21221228	12	R1/4	10	29.9	32.5	20	17
21221238	12	R3/8	11	29.9	29.5	20	17
21221248	12	R1/2	14	29.9	32.5	20	21

CONEXIONES EN ACERO INOXIDABLE

Métrico - Tubo $\varnothing 4$ a 12 mm D.E.

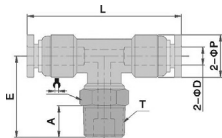
Conexión (T) Orientable Tubo Rosca Macho Central (Cuerda R)



Modelo	$\varnothing D$	T	A	L	E	$\varnothing P$	
212504M5	4	M5X0.8	4	36.6	20.5	10	10
21250418	4	R1/8	7.5	36.6	19.3	10	10
21250428	-	-	-	-	-	-	-
212506M5	6	M5X0.8	3.5	40.2	21.5	12	10
21250618	6	R1/8	7.5	40.2	20.3	12	12
21250628	6	R1/4	10	40.2	22.8	12	14
21250638	-	-	-	-	-	-	-
21250648	-	-	-	-	-	-	-
21250818	8	R1/8	7.5	45.6	23.5	14	14
21250828	8	R1/4	10	45.6	24	14	14
21250838	-	-	-	-	-	-	-
21250848	-	-	-	-	-	-	-
21251018	-	-	-	-	-	-	-
21251028	10	R1/4	10	53.4	28.3	17	17
21251038	10	R3/8	11	53.4	28.8	17	17
21251048	10	R1/2	14	53.4	31.8	17	21
21251228	12	R1/4	10	59.8	32.5	20	17
21251238	12	R3/8	11	59.8	29.5	20	17
21251248	12	R1/2	14	59.8	32.5	20	21

Conexión Recta Hembra

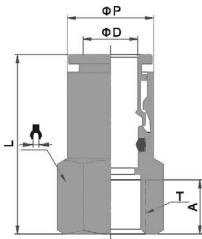

Modelo	D	NTP
21300418	4	1/8
21300428	4	1/4
21300618	6	1/8
21300628	6	1/4
21300818	8	1/8
21300828	8	1/4
21300838	8	3/8
21300848	8	1/2
21301018	10	1/8
21301028	10	1/4
21301038	10	3/8
21301048	10	1/2
21301228	12	1/4
21301238	12	3/8
21301248	12	1/2

Unión Recta Pasamuros

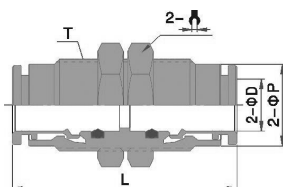

Modelo	$\varnothing D$	T	L	$\varnothing P$	
20690400	4	M12X1.0	37.6	10	14
20690600	6	M14X1.0	38.4	12	17
20690800	8	M16X1.0	40.4	14	19
20691000	10	M18X1.0	44	16	21
20691200	12	M20X1.0	45	18	24

CONEXIONES EN ACERO INOXIDABLE

Métrico - Tubo $\varnothing 4$ a 12 mm D.E.

Banjo regulador de Caudal

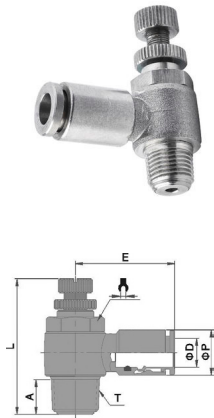

Modelo	D	NTP
21310418	4	1/8
21310428	4	1/4
21310618	6	1/8
21310628	6	1/4
21310818	8	1/8
21310828	8	1/4
21310838	8	3/8
21310848	8	1/2
21311018	10	1/8
21311028	10	1/4
21311038	10	3/8
21311048	10	1/2
21311228	12	1/4
21311238	12	3/8
21311248	12	1/2

(T) Unión Tubos

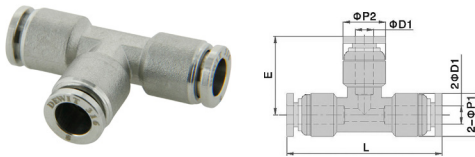

Modelo	$\varnothing D1$	$\varnothing D2$	L1	L2	$\varnothing P1$	$\varnothing P2$
20620400	4	4	36.6	18.3	10	10
20620600	6	6	40.2	20.1	12	12
20620800	8	8	45.6	22.8	14	14
20621000	10	10	53.4	26.7	17	17
20621200	12	12	59.4	29.9	20	20

Codo Tubo-tubo

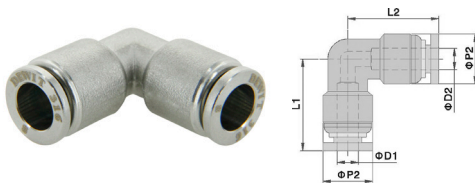

Modelo	$\varnothing D1$	$\varnothing D2$	L1	L2	$\varnothing P1$	$\varnothing P2$
20660400	4	4	18.3	18.3	10	10
20660600	6	6	20.1	20.1	12	12
20660800	8	8	22.8	22.8	14	14
20661000	10	10	26.7	26.7	17	17
20661200	12	12	29.9	29.9	20	20

Unión Tubo-tubo

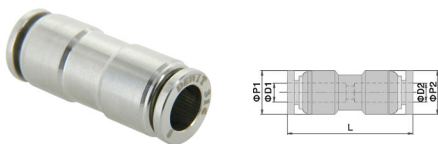

Modelo	$\varnothing D1$	$\varnothing D2$	L	$\varnothing P1$	$\varnothing P2$
20680400	4	4	29	10	10
20680600	6	6	30.6	12	12
20680800	8	8	33.4	14	14
20681000	10	10	37.6	17	17
20681200	12	12	42.4	20	20

CONEXIONES PLÁSTICAS

Pulgadas - Tubo $\varnothing 1/8''$ a $1/2''$ D.E.

Características.

- Todas las cuerdas NPT incluyen teflón adherido.
- Amplia variedad de accesorios en diferentes diámetros.
- El cuerpo de latón niquelado previene la corrosión y contaminación.
- Amplia gama de cuerdas.
- Alta vida útil de los materiales.

Figura.

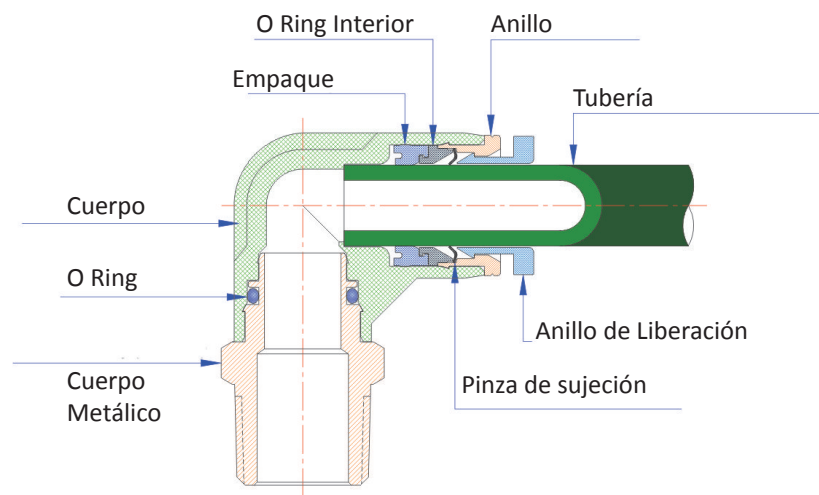

Materiales.

- Cuerpo Metálico: Latón Niquelado
- O-Ring: NBR
- Cuerpo: PBT
- Empaque: NBR
- O-Ring Interior: POM
- Anillo: ZINC
- Tubería: PU, PA, PE
- Anillo de liberación: POM
- Pinza de Sujeción: SUS

Especificaciones Técnicas.

Fluido	Aire, VAcío, Agua
Presión de trabajo	0 ~ 1.2 Mpa
Presión Negativa	750 mm Hg
Temperatura de trabajo	-10° ~ 60 °C
Tamaño de tubería	$1/8''$, $3/32''$, $1/4''$, $3/16''$, $3/8''$, $1/2''$
Tamaño de Roscas	UNF10-32, $1/8$ NPT, $1/4$ NPT, $3/8$ NPT, $1/2$ NPT

CONEXIONES PLÁSTICAS

Pulgadas - Tubo $\varnothing 1/8''$ a $1/2''$ D.E.

Conexión Recta Macho Hexagonal (Cuerda NPT)

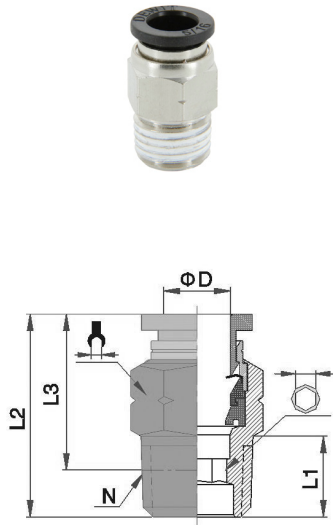



Modelo	$\varnothing D$	N	L1	L2	L3		
0121-1/8-U10	1/8	10-32UNF	3.5	20	16.5	7/16	2
0121-1/8-18	1/8	NPT1/8	7.5	19.5	15.5	7/16	2.4
0121-1/8-28	1/8	NPT1/4	10	19.5	13.5	9/16	2.4
0121-1/8-38	1/8	-	-	-	-	-	-
0121-1/8-48	1/8	-	-	-	-	-	-
0121-5/32-U10	5/32	10-32UNF	3.5	20	16.5	7/16	2
0121-5/32-18	5/32	NPT1/8	7.5	19.5	15.5	7/16	3.2
0121-5/32-28	5/32	NPT1/4	10	19.5	13.5	9/16	3.2
0121-5/32-38	5/32	-	-	-	-	-	-
0121-1/4-U10	1/4	10-32UNF	3.5	21	17.5	1/2	2
0121-1/4-18	1/4	NPT1/8	7.5	21	17	1/2	4
0121-1/4-28	1/4	NPT1/4	10	23	17	9/16	4
0121-1/4-38	1/4	NPT3/8	10.5	21	15	11/16	4
0121-1/4-48	1/4	-	-	-	-	-	-
0121-5/16-28	5/16	NPT1/4	10	25	19.5	9/16	6.4
0121-5/16-38	5/16	NPT3/8	10.5	21.5	15.5	11/16	6.4
0121-5/16-48	5/16	NPT1/2	13.5	25.5	17.58	7/8	6.4
0121-3/8-18	3/8	NPT1/8	7.5	29	22.5	11/16	5.6
0121-3/8-28	3/8	NPT1/4	10	31	25	11/16	6.4
0121-3/8-38	3/8	NPT3/8	10.5	27	21	11/16	8
0121-3/8-48	3/8	NPT1/2	13.5	26	18	7/8	8
0121-1/2-18	1/2	-	-	-	-	-	-
0121-1/2-28	1/2	NPT1/4	10	34	28	7/8	6.4
0121-1/2-38	1/2	NPT3/8	10.5	30.5	24	7/8	9.6
0121-1/2-48	1/2	NPT1/2	13.5	32.5	24.5	7/8	9.6

CONEXIONES PLÁSTICAS

Pulgadas - Tubo $\varnothing 1/8''$ a $1/2''$ D.E.

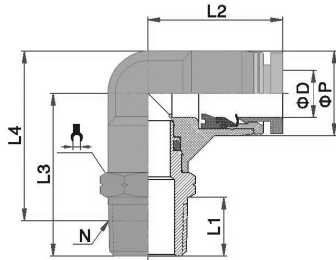
Conexión Codo Macho (Cuerda NPT)



Modelo	$\varnothing D$	G	L1	L2	L3	L4	P	
0122-1/8-U10	1/8	-	-	-	-	-	-	-
0122-1/8-18	1/8	-	-	-	-	-	-	-
0122-1/8-28	1/8	-	-	-	-	-	-	-
0122-1/8-38	1/8	-	-	-	-	-	-	-
0122-1/8-48	1/8	-	-	-	-	-	-	-
0122-5/32-U10	5/32	UNF10-32	3.5	18.5	18.5	20.5	11	1/2
0122-5/32-18	5/32	NTP1/8	7.5	18.5	21	22.5	11	1/2
0122-5/32-28	5/32	NTP1/4	10	18.5	24	23.5	11	9/16
0122-5/32-38	5/32	-	-	-	-	-	-	-
0122-1/4-U10	1/4	UNF10-32	3.5	19.5	19.5	22.5	13	1/2
0122-1/4-18	1/4	NTP1/8	7.5	19.5	22	24.5	13	1/2
0122-1/4-28	1/4	NTP1/4	10	19.5	25	25.5	13	9/16
0122-1/4-38	1/4	NTP3/8	10.5	19.5	26	26	13	11/16
0122-1/4-48	1/4	-	-	-	-	-	-	-
0122-5/16-18	5/16	NTP1/8	7.5	23	25	28.5	14.5	9/16
0122-5/16-28	5/16	NTP1/4	10	23	27.5	29	14.5	9/16
0122-5/16-38	5/16	NTP3/8	10.5	23	28.5	29.5	14.5	11/16
0122-5/16-48	5/16	NTP1/2	13.5	23	32	31	14.5	7/8
0122-3/8-18	3/8	NTP1/8	7.5	27	27	27.5	32.5	18.5
0122-3/8-28	3/8	NTP1/4	10	27	30	33	18.5	11/16
0122-3/8-38	3/8	NTP3/8	10.5	27	30.5	33.5	18.5	11/16
0122-3/8-48	3/8	NTP1/2	13.5	27	34	35	18.5	7/8
0122-1/2-18	1/2	NTP1/8	7.5	29.5	28	34.5	21	11/16
0122-1/2-28	1/2	NTP1/4	10	29.5	30.5	35	21	11/16
0122-1/2-38	1/2	NTP3/8	10.5	29.5	31	35.5	21	11/16
0122-1/2-48	1/2	NTP1/2	13.5	29.5	34.5	36.5	21	7/8

CONEXIONES PLÁSTICAS

Pulgadas - Tubo Ø1/8" a 1/2" D.E.

Conexión (T) Orientable Tubo-Rosca Macho Central (Cuerda NPT)

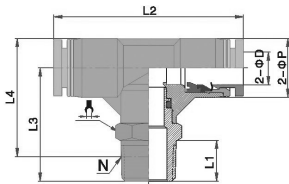

Material (Negro)	D	R	L1	L2	L3	L4	P	HERR
0125-1/8-U10	1/8	10-32UNF	-	-	-	-	-	-
0125-1/8-18	1/8	NPT1/8	-	-	-	-	-	-
0125-1/8-28	1/8	NPT1/4	-	-	-	-	-	-
0125-5/32-U10	5/32	10-32UNF	3.5	3.5	18.5	20.5	11	1/2
0125-5/32-18	5/32	NPT1/8	7.5	7.5	21	22.5	11	1/2
0125-5/32-28	5/32	NPT1/4	10	10	24	23.5	11	9/16
0125-1/4-U10	1/4	10-32UNF	3.5	3.5	19.5	22.5	13	1/2
0125-1/4-18	1/4	NPT1/8	7.5	7.5	22	24.5	13	1/2
0125-1/4-28	1/4	NPT1/4	10	10	25	25.5	13	9/16
0125-1/4-38	1/4	NPT3/8	10.5	10.5	26	26	13	11/16
0125-1/4-48	1/4	NPT1/2	13.5	13.5	29.5	27.5	13	7/8
0125-5/16-18	5/16	NPT1/8	7.5	7.5	25	28.5	14.5	9/16
0125-5/16-28	5/16	NPT1/4	10	10	27.5	29	14.5	9/16
0125-5/16-38	5/16	NPT3/8	10.5	10.5	28.5	29	14.5	11/16
0125-5/16-48	5/16	NPT1/2	13.5	13.5	32	31	14.5	7/8
0125-3/8-18	3/8	NPT1/8	7.5	7.5	27.5	32.5	18.5	11/16
0125-3/8-28	3/8	NPT1/4	10	10	30	33	18.5	11/16
0125-3/8-38	3/8	NPT3/8	10.5	10.5	30.5	33	18.5	11/16
0125-3/8-48	3/8	NPT1/2	13.5	13.5	34	35	18.5	7/8
0125-1/2-28	1/2	NPT1/4	10	10	30.5	35	21	11/16
0125-1/2-38	1/2	NPT3/8	10.5	10.5	31	35	21	11/16
0125-1/2-48	1/2	NPT1/2	13.5	13.5	34.5	36.5	21	7/8

Conexión (T) Orientable Tubo-Rosca Macho Central (Cuerda NPT)

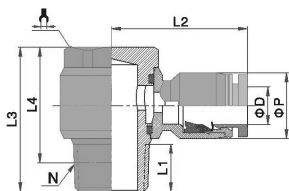

Material (Negro)	D	N	L1	L2	L3	L4	P	HERR
0127-1/8-U10	1/8	UNF-1032	-	-	-	-	-	11/32
0127-1/8-18	1/8	NPT18	-	-	-	-	-	1/2
0127-1/8-28	1/8	NPT1/4	-	-	-	-	-	9/16
0127-1/8-38	5/32	UNF-1032	4	20	17	16	11	11/32
0127-1/8-48	5/32	NPT18	7	23	24	20	11	1/2
0127-5/32-U10	5/32	NPT1/4	9.5	25	26.5	20.5	11	9/16
0127-5/32-18	5/32	NPT3/8	-	-	-	-	-	-
0127-5/32-28	1/4	UNF-1032	4	21.5	17	13	13	11/32
0127-1/4-U10	1/4	NPT18	7	23	24	20	13	1/2
0127-1/4-18	1/4	NPT1/4	9.5	25	26.5	20.5	13	9/16
0127-1/4-28	1/4	NPT3/8	10.5	27	32	25.5	13	3/4
0127-1/4-38	1/4	NPT1/2	14	33	39	31	14.5	1
0127-5/16-18	5/16	NPT18	7	26.5	24	20	14.5	1/2
0127-5/16-28	5/16	NPT1/4	9.5	29	26.5	20.5	14.5	9/16
0127-5/16-38	5/16	NPT3/8	10.5	30.5	32	25.5	14.5	3/4
0127-5/16-48	5/16	NPT1/2	14	33	39	31	14.5	1
0127-3/8-18	3/8	NPT18	7	29	24	20	18.5	1/2
0127-3/8-28	3/8	NPT1/4	9.5	31	26.5	20.5	18.5	9/16
0127-3/8-38	3/8	NPT3/8	10.5	32	32	25.5	18.5	3/4
0127-3/8-48	3/8	NPT1/2	14	34.5	39	31	18.5	1
0127-1/2-18	1/2	NPT18	-	-	-	-	-	1/2
0127-1/2-28	1/2	NPT1/4	9.5	33	26.5	20.5	21	9/16
0127-1/2-38	1/2	NPT3/8	10.5	33.5	32	25.5	21	3/4
0127-1/2-48	1/2	NPT1/2	14	36.5	39	31	21	1

CONEXIONES PLÁSTICAS

Pulgadas - Tubo $\varnothing 1/8''$ a $1/2''$ D.E.

Conexión Recta Hembra (Cuerda NPT)

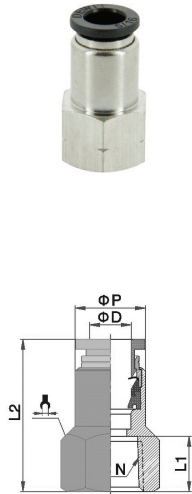

Modelo (Negro)	D	N	L1	L2	HER
0130-1/8-U10	1/8	UNF-1032	-	-	7/16
0130-1/8-18	1/8	NPT18	-	-	7/16
0130-1/8-28	1/8	NPT1/4	-	-	9/16
0130-5/32-U10	5/32	UNF-1032	5	21.5	7/16
0130-5/32-18	5/32	NPT18	8.5	24.5	7/16
0130-5/32-28	5/32	NPT1/4	11	27	7/16
0130-5/32-38	5/32	NPT3/8	-	-	11/16
0130-1/4-U10	1/4	UNF-1032	5	22	1/2
0130-1/4-18	1/4	NPT18	5	22	1/2
0130-1/4-28	1/4	NPT1/4	8.5	25.5	1/2
0130-1/4-38	1/4	NPT3/8	11	28	1/2
0130-1/4-48	1/4	NPT1/2	11.5	28.5	1/2
0130-5/16-18	5/16	NPT18	8.5	27.5	9/16
0130-5/16-28	5/16	NPT1/4	11	30	9/16
0130-5/16-38	5/16	NPT3/8	11.5	30.5	9/16
0130-5/16-48	5/16	NPT1/2	14	33	9/16
0130-3/8-18	3/8	NPT18	8.5	30	11/16
0130-3/8-28	3/8	NPT1/4	11	32.5	11/16
0130-3/8-38	3/8	NPT3/8	11.5	33	11/16
0130-3/8-48	3/8	NPT1/2	14	35.5	11/16
0130-1/2-18	1/2	NPT18	11	34	7/8
0130-1/2-28	1/2	NPT1/4	11	35	7/8
0130-1/2-38	1/2	NPT3/8	11.5	35.5	7/8
0130-1/2-48	1/2	NPT1/2	14	38	7/8

Banjo Regulador de Caudal (Cuerda NPT)



Modelo	$\varnothing D$	T	A	E1	E2	B		L		P	
						MIN	MAX	MIN	MAX		
0131-1/8-U10	1/8	-	-	-	-	-	-	-	-	-	-
0131-1/8-18	1/8	-	-	-	-	-	-	-	-	-	-
0131-1/8-28	1/8	-	-	-	-	-	-	-	-	-	-
0131-1/8-38	1/8	-	-	-	-	-	-	-	-	-	-
0131-1/8-48	1/8	-	-	-	-	-	-	-	-	-	-
0131-5/32-U10	5/32	10-32UNF	3.5	19.5	7.5	29	32	25.5	28.5	11	8
0131-5/32-18	5/32	NPT1/8	7.5	22.5	10.5	35	40	31	36	13	12
0131-5/32-28	5/32	NPT1/4	10.5	24.5	12.5	41	46.5	35	40.5	13	14
0131-1/4-U10	1/4	10-32UNF	3.5	21.5	8.5	29	32	25.5	28.5	13	8
0131-1/4-18	1/4	NPT1/8	7.5	22.5	10.5	35	40	31	36	13	12
0131-1/4-28	1/4	NPT1/4	10.5	24.5	12.5	41	46.5	35	40.5	13	14
0131-1/4-38	1/4	NPT3/8	11.5	26.5	14	46.5	52	40	45.5	13	19
0131-5/16-18	5/16	NPT1/8	7.5	25	11.5	35	40	31	36	14.5	12
0131-5/16-28	5/16	NPT1/4	10.5	28	13	41	46.5	35	40.5	14.5	14
0131-5/16-38	5/16	NPT3/8	11.5	29	14.5	46.5	52	40	45.5	14.5	19
0131-5/16-48	5/16	NPT1/2	15	32	18	54	60	46	52	14.5	24
0131-3/8-18	3/8	NPT1/8	7.5	30.5	13.5	35	40	31	36	18.5	12
0131-3/8-28	3/8	NPT1/4	10.5	32.5	15	41	46.5	35	40.5	18.5	14
0131-3/8-38	3/8	NPT3/8	11.5	33	16.5	46.5	52	40	45.5	18.5	19
0131-3/8-48	3/8	NPT1/2	15	36	18	54	60	46	52	18.5	24
0131-1/2-28	1/2	NPT1/4	10.5	33	16.5	46.5	52	40	45.5	21	14
0131-1/2-38	1/2	NPT3/8	11.5	35	18	54	60	46	52	21	19
0131-1/2-48	1/2	NPT1/2	15	36	19.5	54	60	46	52	21	24

CONEXIONES PLÁSTICAS

Pulgadas - Tubo $\varnothing 1/8''$ a $1/2''$ D.E.

Conexión Hembra Pasamuros (Cuerda NPT)

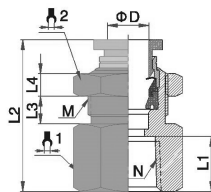

Modelo (Negro)	D	N	L1	L2	L3	L4	M	HERR 1	HERR 2
0133-1/8-U10	1/8	UNF-1032	-	-	-	-	-	-	-
0133-1/8-18	1/8	NPT18	-	-	-	-	-	9/16	9/16
0133-1/8-28	1/8	NPT1/4	-	-	-	-	-	11/16	11/16
0133-5/32-U10	5/32	UNF-1032	-	-	-	-	-	11/16	11/16
0133-5/32-18	5/32	NPT18	8.5	24.5	5	3.5	M12*1.0	9/16	9/16
0133-5/32-28	5/32	NPT1/4	11	27	8	3.5	M12*1.0	11/16	11/16
0133-1/4-U10	1/4	UNF-1032	-	-	-	-	-	-	-
0133-1/4-18	1/4	NPT18	8.5	25.5	5.5	4	M14*1.0	11/16	11/16
0133-1/4-28	1/4	NPT1/4	11	28.5	5.5	4	M14*1.0	11/16	11/16
0133-1/4-38	1/4	NPT3/8	11.5	29	5.5	4	M14*1.0	1	11/16
0133-5/16-18	5/16	NPT18	8.5	27.5	5.5	4.5	M16*1.0	3/4	3/4
0133-5/16-28	5/16	NPT1/4	11	30	5.5	4.5	M16*1.0	3/4	3/4
0133-5/16-38	5/16	NPT3/8	11.5	30.5	5.5	4.5	M16*1.0	13/16	3/4
0133-5/16-48	5/16	NPT1/2	14	33	5.5	4.5	M16*1.0	1	3/4
0133-3/8-18	3/8	NPT18	-	-	-	-	-	11/16	11/16
0133-3/8-28	3/8	NPT1/4	11	32.5	7	5	M18*1.0	13/16	13/16
0133-3/8-38	3/8	NPT3/8	11.5	33	7	5	M18*1.0	13/16	13/16
0133-3/8-48	3/8	NPT1/2	14	35.5	7	5	M18*1.0	1	13/16
0133-1/2-28	1/2	NPT1/4	11	35	9	5	M22*1.0	1 1/16	1 1/16
0133-1/2-38	1/2	NPT3/8	11.5	35.5	9	5	M22*1.0	1 1/16	1 1/16
0133-1/2-48	1/2	NPT1/2	14	38	9	5	M22*1.0	1 1/16	1 1/16

Banjo Doble Horizontal (Cuerda NPT)

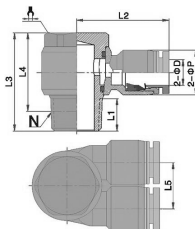

Modelo (Negro)	D	N	L1	L2	L3	L4	L5	P	HERR
0134-1/8-U10	1/8	UNF-1032	-	-	-	-	-	-	-
0134-1/8-18	1/8	NPT18	-	-	-	-	-	-	-
0134-1/8-28	1/8	NPT1/4	-	-	-	-	-	-	-
0134-5/32-28	5/32	NPT1/4	-	-	-	-	-	-	-
0134-1/4-18	1/4	NPT18	7	24	24	20	13	13	1/2
0134-3/8-28	3/8	NPT1/4	9.5	31	26.5	20.5	18.5	18.5	9/16
0134-3/8-38	3/8	NPT3/8	10.5	33	32	25.5	18.5	18.5	3/4
0134-1/2-38	1/2	NPT3/8	10.5	34	32	25.5	21	21	3/4
0134-1/2-48	1/2	NPT1/2	14	36.5	39	31	21	21	1

CONEXIONES PLÁSTICAS

Pulgadas - Tubo $\varnothing 1/8''$ a $1/2''$ D.E.

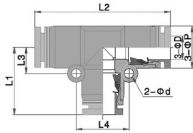

(T) Unión Tubos

Modelo	D1	ϕP	$\phi L1$	L2	L3	L4	ϕd
0062-1/8	-	-	-	-	-	-	-
0062-5/32	5/32	11	18.5	37	7	14	3.2
0062-1/4	1/4	13	19	38	8	16	3.2
0062-5/16	5/16	14.5	23	46	9	18	3.2
0062-3/8	3/8	18.5	27.5	55	11.5	23	4.2
0062-1/2	1/2	21	29	58	13	26	4.2

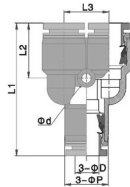

(Y) Unión Tubos

Modelo	ϕD	L1	L2	L3	ϕP	ϕd
0064-1/8	1/8	-	-	-	-	-
0064-5/32	5/32	35.5	14	11	11	3.2
0064-1/4	1/4	38	15	13	13	3.2
0064-5/16	5/16	44.5	18.5	14.5	14.5	3.2
0064-3/8	3/8	50	21	18	18.5	4.2
0064-1/2	1/2	55	22	21	21	4.2

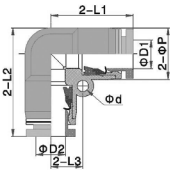

Codo Tubo-tubo

Modelo	$\phi D1$	$\phi D2$	L1	L2	L3	$\phi P2$	ϕd
0066-1/8	1/8	-	-	-	-	-	-
0066-5/32	5/32	-	18.5	24	7	11	3.2
0066-1/4	1/4	-	19	25.5	8	13	3.2
0066-5/16	5/16	-	23	30.5	9	14.5	3.2
0066-3/8	3/8	-	27.5	37	11.5	18.5	4.2
0066-1/2	1/2	-	29	39.5	13	21	4.2

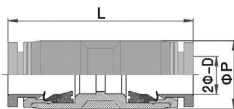

Unión Tubo-tubo

Modelo (Negro)	Modelo (Blanco)	$\phi D1$	L1	L2	ϕP	ϕd
0068-5/32	0068-5/32	5/32	32.5	13.5	11	3.2
0068-1/4	W-0068-1/4	1/4	35	16	13	3.2
0068-5/16	W-0068-5/16	5/16	38	17	14.5	3.2
0068-3/8	W-0068-3/8	3/8	48	21.5	18.5	4.2
0068-1/2	W-0068-1/2	1/2	48	24	21	4.2

CONEXIONES PLÁSTICAS

Pulgadas - Tubo $\varnothing 1/8''$ a $1/2''$ D.E.

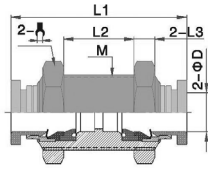

Unión Recta Pasamuros

Modelo	$\varnothing D$	M	L1	L2	L3	
0069-1/8	3/16	M12*1.0	31	13	3.5	14
0069-5/32	5/32	-	-	-	-	-
0069-1/4	1/4	M14*1.0	33	13	4	17
0069-5/16	5/16	M16*1.0	37.5	15	4.5	18
0069-3/8	3/8	M18*1.0	42.5	18.5	5	21
0069-1/2	1/2	M22*1.0	45.5	20	5	27

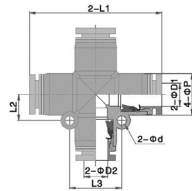

Conexión Cruz

Modelo	$\varnothing D1$	$\varnothing D2$	$\varnothing P$	L1	L2	L3	$\varnothing d$
0070-1/8	1/8	1/8	-	-	-	-	-
0070-5/32	5/32	5/32	11	37	7.5	15	3.2
0070-1/4	1/4	1/4	13	38	8	16	3.2
0070-5/16	5/16	5/16	14.5	45	9	18	3.2
0070-3/8	3/8	3/8	18.5	56	11.5	23	4.2
0070-1/2	1/2	1/2	21	58	13	26	4.2

Unión Tubo Reductor



Modelo (Negro)	$\varnothing D1$	$\varnothing D2$	L1	L2	P1	P2	$\varnothing d$
0074-1/8-5/32	-	-	-	-	-	-	-
0074-1/8-1/4	-	-	-	-	-	-	-
0074-1/8-5/16	-	-	-	-	-	-	-
0074-1/8-3/8	-	-	-	-	-	-	-
0074-1/8-5/32	1/4	5/32	34	15	13	11	3.2
0074-5/16-5/32	5/16	5/32	36	16.5	14.5	13	3.2
0074-5/16-1/4	5/16	1/4	36.5	16.5	14.5	13	3.2
0074-3/8-1/4	3/8	1/4	46.5	19.5	18.5	14.5	3.2
0074-3/8-5/16	3/8	5/16	47	19.5	18.5	14.5	3.2
0074-1/2-5/16	1/2	5/16	47	23.5	21	18.5	4.2
0074-1/2-3/8	1/2	3/8	48	23.5	21	18.5	4.2

Adaptador de Reducción

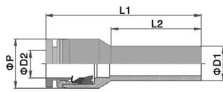

Modelo	$\varnothing D1$	$\varnothing D2$	L1	L2	$\varnothing P$
0075-1/8-5/32	1/4	5/32	38.5	22	11
0075-1/8-1/4	5/16	5/32	40	25	11
0075-1/8-5/16	5/16	1/4	41	25	13
0075-1/8-3/8	3/8	1/4	41	26.5	13
0075-1/4-5/32	3/8	5/16	45.5	26.5	14.5
0075-5/16-5/32	1/2	1/4	40	26.5	13
0075-5/16-1/4	1/2	5/16	43	26.5	14.5
0075-3/8-1/4	1/2	3/8	51	26.5	18.5
0075-3/8-5/16	-	-	-	-	-
0075-1/2-5/16	-	-	-	-	-
0075-1/2-3/8	-	-	-	-	-

CONEXIONES PLÁSTICAS

Pulgadas - Tubo $\varnothing 1/8''$ a $1/2''$ D.E.

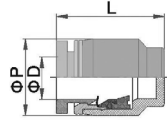

Conexión Tapón

Modelo	$\varnothing D$	$\varnothing P$	L
0079-1/8	5/32	11	18
0079-5/32	3/16	11	18
0079-1/4	1/4	13	19
0079-5/16	5/16	14.5	21
0079-3/8	3/8	18.5	23
0079-1/2	1/2	21	25

Reductor

Modelo	D1	D2	L	L1	L2
0080-1/8-5/32	-	-	-	-	-
0080-1/8-1/4	-	-	-	-	-
0080-1/8-5/16	-	-	-	-	-
0080-1/8-3/8	-	-	-	-	-
0080-1/4-5/32	-	-	-	-	-
0080-5/16-5/32	-	-	-	-	-
0080-5/16-1/4	-	-	-	-	-
0080-3/8-1/4	-	-	-	-	-
0080-3/8-5/16	-	-	-	-	-
0080-1/2-5/16	-	-	-	-	-
0080-1/2-3/8	-	-	-	-	-



Válvula Reguladora Tubo-tubo

Modelo	$\varnothing D$	B1	B2	L		P	M1	M2	$\varnothing d$
				MIN	MAX				
00NSF-1/8	-	-	-	-	-	-	-	-	-
00NSF-5/32	5/32	40	11.5	27	29.5	11	14	6.5	3.2
00NSF-1/4	1/4	47	15	39	44.5	13	20	8.5	4.2
00NSF-5/16	5/16	52	18	42.5	47.5	14.5	22	9.5	4.2
00NSF-3/8	3/8	63.5	21	46.5	52.5	18.5	26	11	4.2
00NSF-1/2	1/2	74	28	54	59	21	32	14	4.2

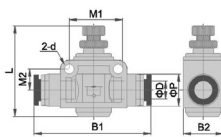

Válvula Manual Tubo-tubo

Modelo	$\varnothing D1$	$\varnothing D2$	L	E1	E2	P	C1	C2	F1	F2
00HVF-1/8	-	-	-	-	-	-	-	-	-	-
00HVF-5/32	-	-	-	-	-	-	-	-	-	-
00HVF-1/4	1/4	1/4	37.5	26	26	14.5	16	16	18	8
00HVF-5/16	5/16	5/16	37.5	27	27	14.5	18.5	18.5	18	8
00HVF-3/8	3/8	3/8	40.5	35	35	21	20	20	24	11
00HVF-1/2	1/2	1/2	40.5	34.5	34.5	21	23	23	24	11

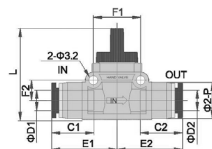

CONEXIONES METÁLICAS

Pulgadas - Tubo $\varnothing 1/8''$ a $1/2''$ D.E.

Características.

- Estos conectores están fabricados en Latón Niquelado.
- Tienen una excelente resistencia la fuego, a las altas temperaturas y al agua.
- Presionar el anillo de liberación al insertar o remover la tubería para evitar dañar la misma.

Figura.

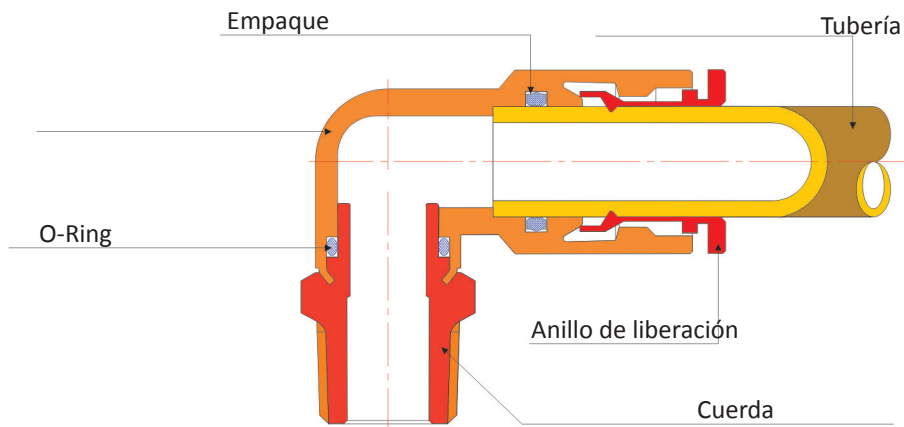

Materiales.

- Cuerpo Metálico: Latón Niquelado
- O-Ring: FKM
- Empaque: FKM
- Tubería: PU, PA, PE
- Anillo de liberación: Latón Niquelado
- Cuerda: Latón Niquelado

Especificaciones Técnicas.

Fluido	Aire, VAcío, Agua
Presión de trabajo	0 ~ 1.8 Mpa
Presión Negativa	750 mm Hg
Temperatura de trabajo	-20° ~ 80 °C
Tamaño de tubería	$1/8''$, $3/32''$, $1/4''$, $3/16''$, $1/8''$, $1/2''$
Tamaño de Roscas	UNF10-32, $1/8$ NPT, $1/4$ NPT, $3/8$ NPT, $1/2$ NPT

CONEXIONES METÁLICAS

Pulgadas - Tubo $\varnothing 1/8''$ a $1/2''$ D.E.

Conexión Recta Macho (Cuerda NPT)

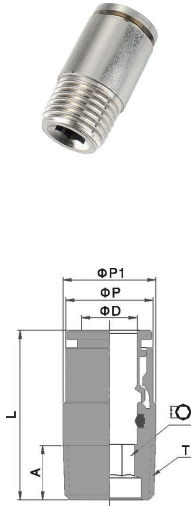

Modelo	$\varnothing D$	T	A	L	$\varnothing P1$	$\varnothing P2$	$\varnothing I$
1121A-5/32-U10	5/32	10-32UNF	3.5	23.5	10	10	2
1121A-5/32-18	5/32	NPT1/8	8	23	10	10	3
1121A-5/32-28	5/32	NPT1/4	10	23	13.4	10	3
1121A-1/4-U10	1/4	10-32UNF	3.5	24.2	12	12	2
1121A-1/4-18	1/4	NPT1/8	8	24.5	12	12	5
1121A-1/4-28	1/4	NPT1/4	10	24.7	13.4	12	5
1121A-1/4-38	1/4	NPT3/8	-	-	13.4	12	5
1121A-1/4-48	1/4	NPT1/2	-	-	13.4	12	5
1121A-5/16-18	5/16	NPT1/8	8	28.2	14	14	5
1121A-5/16-28	5/16	NPT1/4	10	27.2	14	14	6
1121A-5/16-38	5/16	NPT3/8	11	27.2	17	14	6
1121A-5/16-48	5/16	NPT1/2	14	27.2	21	14	6
1121A-3/8-18	3/8	NPT1/8	8	30.7	16	16	5
1121A-3/8-28	3/8	NPT1/4	10	31.2	16	16	6
1121A-3/8-38	3/8	NPT3/8	11	31.2	17	16	8
1121A-3/8-48	3/8	NPT1/2	14	31.2	21	16	8
1121A-1/2-28	1/2	NPT1/4	10	33.2	18	18	6
1121A-1/2-38	1/2	NPT3/8	11	32.2	18	18	8
1121A-1/2-48	1/2	NPT1/2	14	31.7	21	18	8

Conexión Recta Macho Hexagonal (Cuerda NPT)

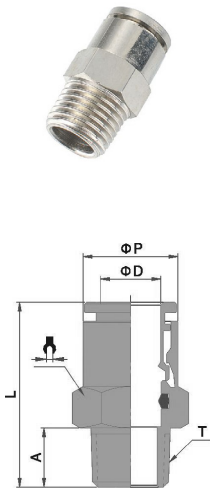

Modelo	$\varnothing D$	T	A	L	$\varnothing P$	$\varnothing I$
1121-5/32-U10	5/32	10-32UNF	3.5	23.5	10	10
1121-5/32-18	5/32	NPT1/8	8	23	10	10
1121-5/32-28	5/32	NPT1/4	10	23.5	10	14
1121-1/4-U10	1/4	10-32UNF	3.5	24.2	12	12
1121-1/4-18	1/4	NPT1/8	8	24.5	12	12
1121-1/4-28	1/4	NPT1/4	10	24.7	12	14
1121-1/4-38	1/4	NPT3/8	-	-	12	14
1121-1/4-48	1/4	NPT1/2	-	-	12	14
1121-5/16-18	5/16	NPT1/8	8	28.2	14	14
1121-5/16-28	5/16	NPT1/4	10	27.2	14	14
1121-5/16-38	5/16	NPT3/8	11	27.2	14	17
1121-5/16-48	5/16	NPT1/2	14	27.2	14	21
1121-3/8-18	3/8	NPT1/8	8	30.7	16	17
1121-3/8-28	3/8	NPT1/4	10	31.2	16	17
1121-3/8-38	3/8	NPT3/8	11	31.2	16	17
1121-3/8-48	3/8	NPT1/2	14	31.2	16	21
1121-1/2-28	1/2	NPT1/4	10	33.2	18	19
1121-1/2-38	1/2	NPT3/8	11	32.2	18	19
1121-1/2-48	1/2	NPT1/2	14	31.7	18	21

CONEXIONES METÁLICAS

Pulgadas - Tubo $\varnothing 1/8''$ a $1/2''$ D.E.

Conexión Codo Macho (Cuerda NPT)

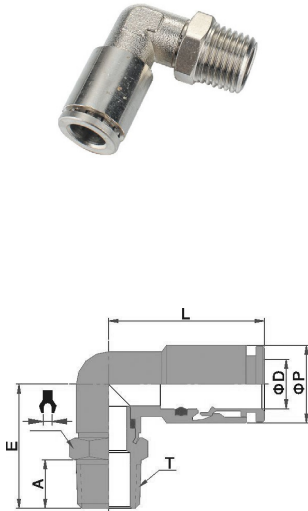

Modelo	$\varnothing D$	T	A	L	E	$\varnothing P$	
1122-5/32-U10	5/32	10-32UNF	3.5	23.5	15.8	10	8
1122-5/32-18	5/32	NPT1/8	8	-	19.3	-	10
1122-5/32-28	5/32	NPT1/4	10	-	21.8	-	14
1122-1/4-U10	1/4	10-32UNF	3.5	24.7	16.8	12	10
1122-1/4-18	1/4	NPT1/8	8	-	20.4	-	-
1122-1/4-28	1/4	NPT1/4	10	-	22.9	-	14
1122-1/4-38	1/4	NPT3/8	-	-	-	-	-
1122-1/4-48	1/4	NPT1/2	-	-	-	-	-
1122-5/16-18	5/16	NPT1/8	8	27.2	22.5	14	12
1122-5/16-28	5/16	NPT1/4	10	-	24.5	-	14
1122-5/16-38	5/16	NPT3/8	11	-	25.5	-	17
1122-5/16-48	5/16	NPT1/2	14	-	29	-	21
1122-3/8-18	3/8	NPT1/8	8	31.7	23.5	16	14
1122-3/8-28	3/8	NPT1/4	10	-	25.5	-	-
1122-3/8-38	3/8	NPT3/8	11	-	26.5	-	17
1122-3/8-48	3/8	NPT1/2	14	-	30	-	21
1122-1/2-28	1/2	NPT1/4	10	32.2	26.7	18	17
1122-1/2-38	1/2	NPT3/8	11	-	27.7	-	-
1122-1/2-48	1/2	NPT1/2	14	-	31.2	-	21

Conexión (T) Orientable Tubo-Rosca Macho Central (Cuerda NPT)

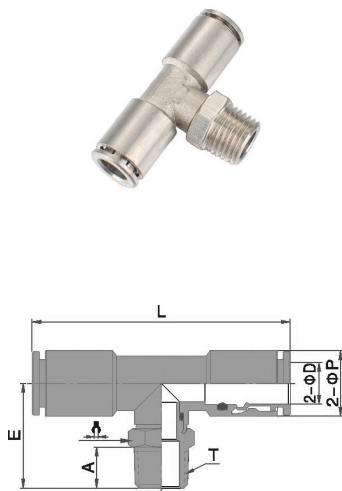

Modelo	$\varnothing D$	T	A	L	E	$\varnothing P$	
1125-5/32-U10	5/32	10-32UNF	3.5	47	15.8	10	8
1125-5/32-18	5/32	NPT1/8	8	47	19.3	10	10
1125-5/32-28	5/32	NPT1/4	10	47	21.8	10	14
1125-1/4-U10	1/4	10-32UNF	3.5	49.5	16.8	12	10
1125-1/4-18	1/4	NPT1/8	8	49.5	20.4	12	10
1125-1/4-28	1/4	NPT1/4	10	49.5	22.9	12	14
1125-1/4-38	1/4	NPT3/8	-	49.5	-	12	14
1125-1/4-48	1/4	NPT1/2	-	49.5	-	12	14
1125-5/16-18	5/16	NPT1/8	8	55.4	22.5	14	12
1125-5/16-28	5/16	NPT1/4	10	55.4	24.5	14	14
1125-5/16-38	5/16	NPT3/8	11	55.4	25.5	14	17
1125-5/16-48	5/16	NPT1/2	14	55.4	29	14	21
1125-3/8-18	3/8	NPT1/8	8	63.4	23.5	16	14
1125-3/8-28	3/8	NPT1/4	10	63.4	25.5	16	14
1125-3/8-38	3/8	NPT3/8	11	63.4	26.5	16	17
1125-3/8-48	3/8	NPT1/2	14	63.4	30	16	21
1125-1/2-28	1/2	NPT1/4	10	64.4	26.7	18	17
1125-1/2-38	1/2	NPT3/8	11	64.4	27.7	18	17
1125-1/2-48	1/2	NPT1/2	14	64.4	31.2	18	21

CONEXIONES METÁLICAS

Pulgadas - Tubo $\varnothing 1/8''$ a $1/2''$ D.E.Z H

Conexión Recta Hembra (Cuerda NPT)

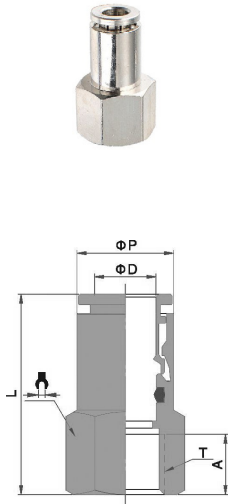

Modelo	ϕD	T	A	L	ϕP	
1130-5/32-U10	5/32	10-32UNF	5	24.5	10	10
1130-5/32-18	5/32	NPT1/8	8	27.5	10	14
1130-5/32-28	5/32	NPT1/4	10	30	10	17
1130-1/4-U10	1/4	10-32UNF	5	24.7	12	12
1130-1/4-18	1/4	NPT1/8	8	28.2	12	14
1130-1/4-28	1/4	NPT1/4	10	30.7	12	17
1130-1/4-38	1/4	NPT3/8	-	-	12	17
1130-1/4-48	1/4	NPT1/2	-	-	12	17
1130-5/16-18	5/16	NPT1/8	8	28.7	14	14
1130-5/16-28	5/16	NPT1/4	10	31.5	14	17
1130-5/16-38	5/16	NPT3/8	11	32.5	14	20
1130-5/16-48	5/16	NPT1/2	14	34.5	14	24
1130-3/8-18	3/8	NPT1/8	8	29.7	16	17
1130-3/8-28	3/8	NPT1/4	10	33.2	16	17
1130-3/8-38	3/8	NPT3/8	11	34.2	16	20
1130-3/8-48	3/8	NPT1/2	14	36.2	16	24
1130-1/2-28	1/2	NPT1/4	10	33.7	18	19
1130-1/2-38	1/2	NPT3/8	11	34.7	18	20
1130-1/2-48	1/2	NPT1/2	14	36.7	18	24

Banjo Regulador de Caudal (Cuerda NPT)

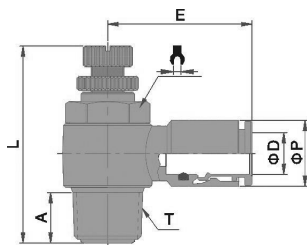

Modelo	ϕD	T	A	L-MIN	L-MAX	E	ϕP	
1131-5/32-U10	5/32	10-32UNF	3.5	29	31.5	23.5	10	8
1131-5/32-18	5/32	NPT1/8	8	35	40.5	24	10	12
1131-5/32-28	5/32	NPT1/4	10	41.5	47	26	10	14
1131-1/4-U10	1/4	10-32UNF	3.5	29	31.5	24.2	12	8
1131-1/4-18	1/4	NPT1/8	8	35	40.5	24	12	12
1131-1/4-28	1/4	NPT1/4	10	41.5	47	26	12	14
1131-5/16-18	5/16	NPT1/8	8	35	40.5	25.5	14	12
1131-5/16-28	5/16	NPT1/4	10	41.5	47	27.5	14	14
1131-5/16-38	5/16	NPT3/8	11	48	53.5	29.5	14	19

CONEXIONES METÁLICAS

Pulgadas - Tubo $\varnothing 1/8''$ a $1/2''$ D.E.

(T) Unión Tubos

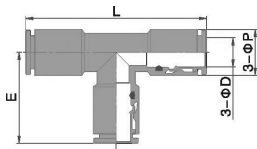

Modelo	$\varnothing D$	L	E	$\varnothing P$
1062-5/32	5/32	47	23.5	10
1062-1/4	1/4	49.4	24.7	12
1062-5/16	5/16	55.4	27.7	14
1062-3/8	3/8	63.4	31.7	16
1062-1/2	1/2	64.4	32.2	18

Codo Tubo-tubo

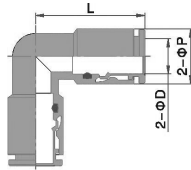

Modelo	$\varnothing D$	L	$\varnothing P$
1066-5/32	5/32	23.5	10
1066-1/4	1/4	24.7	12
1066-5/16	5/16	27.7	14
1066-3/8	3/8	31.7	16
1066-1/2	1/2	32.2	18

Unión Tubo-tubo

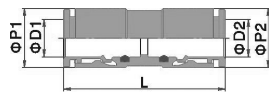

Modelo	$\varnothing D1$	$\varnothing D2$	L	$\varnothing P1$	$\varnothing P2$
1068-5/32	5/32	5/32	37.6	10	10
1068-1/4	1/4	1/4	38.4	12	12
1068-5/16	5/16	5/16	40.4	14	14
1068-3/8	3/8	3/8	44	16	16
1068-1/2	1/2	1/2	45	18	18

Unión Recta Pasamuros

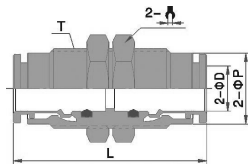

Modelo	$\varnothing D$	T	L	$\varnothing P$	
1069-5/32	5/32	M12X1.0	37.6	10	14
1069-1/4	1/4	M14X1.0	38.4	12	17
1069-5/16	5/16	M16X1.0	40.4	14	19
1069-3/8	3/8	M18X1.0	44	16	21
1069-1/2	1/2	M20X1.0	45	18	24

ACCESORIOS

Silenciadores.



Mini Silenciador de Bronce

Modelo	Conexión	Presión de trabajo	Temperatura de trabajo
81410118	1/8	1.0MPa	(-20)-80°C
81410128	1/4	1.0MPa	(-20)-80°C
81410138	3/8	1.0MPa	(-20)-80°C
81410148	1/2	1.0MPa	(-20)-80°C
81410168	3/4	1.0MPa	(-20)-80°C
81410188	1	1.0MPa	(-20)-80°C



Silenciador de Bronce Sinterizado

Modelo	Conexión	Presión de trabajo	Temperatura de trabajo
81420118	1/8	1.0MPa	(-20)-80°C
81420128	1/4	1.0MPa	(-20)-80°C
81420138	3/8	1.0MPa	(-20)-80°C
81420148	1/2	1.0MPa	(-20)-80°C
81420168	3/4	1.0MPa	(-20)-80°C
81420188	1	1.0MPa	(-20)-80°C
81420198	2	1.0MPa	(-20)-80°C



Silenciador de Bronce Regulable

Modelo	Conexión	Presión de trabajo	Temperatura de trabajo
81430118	1/8	1.0MPa	(-20)-80°C
81430128	1/4	1.0MPa	(-20)-80°C
81430138	3/8	1.0MPa	(-20)-80°C
81430148	1/2	1.0MPa	(-20)-80°C
81430168	3/4	1.0MPa	(-20)-80°C
81430188	1	1.0MPa	(-20)-80°C



Silenciador con Válvula Regulable 1

Modelo	Conexión	Presión de trabajo	Temperatura de trabajo
81440118	1/8	1.0MPa	(-20)-80°C
81440128	1/4	1.0MPa	(-20)-80°C
81440138	3/8	1.0MPa	(-20)-80°C
81440148	1/2	1.0MPa	(-20)-80°C
81440168	3/4	1.0MPa	(-20)-80°C
81440188	1	1.0MPa	(-20)-80°C



Silenciador de Bronce Regulable

Modelo	Conexión	Presión de trabajo	Temperatura de trabajo
81450118	1/8	1.0MPa	(-20)-80°C
81450128	1/4	1.0MPa	(-20)-80°C
81450138	3/8	1.0MPa	(-20)-80°C
81450148	1/2	1.0MPa	(-20)-80°C
81450168	3/4	1.0MPa	(-20)-80°C
81450188	1	1.0MPa	(-20)-80°C

ACCESORIOS

Silenciadores.

Mini Silenciador de Acero Inoxidable



Modelo	Conexión	Presión de trabajo	Temperatura de trabajo
81510218	1/8	1.0MPa	(-20)-80°C
81510228	1/4	1.0MPa	(-20)-80°C
81510238	3/8	1.0MPa	(-20)-80°C
81510248	1/2	1.0MPa	(-20)-80°C
81510268	3/4	1.0MPa	(-20)-80°C
81510288	1	1.0MPa	(-20)-80°C

Silenciador de Acero Inoxidable



Modelo	Conexión	Presión de trabajo	Temperatura de trabajo
81520218	1/8	1.0MPa	(-20)-80°C
81520228	1/4	1.0MPa	(-20)-80°C
81520238	3/8	1.0MPa	(-20)-80°C
81520248	1/2	1.0MPa	(-20)-80°C
81520268	3/4	1.0MPa	(-20)-80°C
81520288	1	1.0MPa	(-20)-80°C

Silenciador de Plástico Poroso



Modelo	Conexión	Presión de trabajo	Temperatura de trabajo
81580218	1/8	1.0MPa	(-20)-80°C
81580228	1/4	1.0MPa	(-20)-80°C
81580238	3/8	1.0MPa	(-20)-80°C
81580248	1/2	1.0MPa	(-20)-80°C
81580268	3/4	1.0MPa	(-20)-80°C
81580288	1	1.0MPa	(-20)-80°C

Silenciador de Plástico



Modelo	Conexión	Presión de trabajo	Temperatura de trabajo
81380218	1/8	1.0MPa	(-20)-80°C
81380228	1/4	1.0MPa	(-20)-80°C
81380238	3/8	1.0MPa	(-20)-80°C
81380248	1/2	1.0MPa	(-20)-80°C

Silenciador de Plástico 2



Modelo	Conexión	Presión de trabajo	Temperatura de trabajo
81390018	1/8	1.0MPa	(-20)-80°C
81390028	1/4	1.0MPa	(-20)-80°C
81390038	3/8	1.0MPa	(-20)-80°C
81390048	1/2	1.0MPa	(-20)-80°C

ACCESORIOS

Coples.



Acople Rápido Hembra

Modelo	NPT
61YCF028	1/4
61YCF038	3/8
61YCF048	1/2



Acople Rápido Macho

Modelo	NPT
61YCM028	1/4
61YCM038	3/8
61YCM048	1/2



Acople Rápido Macho-ARO

Modelo	NPT
61YHM028	1/4
61YHM038	3/8
61YHM048	1/2



Acople Rápido Hembra-ARO

Modelo	NPT
61YHF028	1/4
61YHF038	3/8
61YHF048	1/2



Acople Rápido Manguera

Modelo	NPT
61YCN028	8mm
61YCN038	10mm
61YCN048	12mm



Acople Rápido Manguera-ARO

Modelo	NPT
61YHN028	8mm
61YHN038	10mm
61YHN048	12mm



Conexión Manguera

Modelo	NPT
61RPC0828	1/4
61RPC1048	1/2
61RPC1248	1/2



Conexión Manguera Giratoria

Modelo	NPT
61RSPC0828	1/4
61RSPC1048	1/2
61RSPC1248	1/2

ACCESORIOS

Adaptadores.

Niple Doble Adaptador Macho

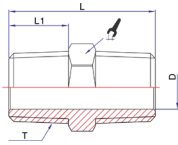

Modelo	T	L	L1	D	
ACS-JW-18	PT1/8-28	22.5	9	6.5	10
ACS-JW-28	PT1/4-19	27	11	8.8	14
ACS-JW-38	PT3/8-19	29.5	12	11.8	17
ACS-JW-48	PT1/2-14	36	15	14.8	21
ACS-JW-68	PT3/4-14	42	17	20	27

Niple Doble Adaptador Macho

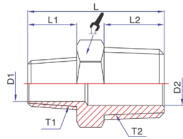

Modelo	T1	T2	L	L1	L2	D1	D2	
ACS-JWG18-28	PT1/8-28	PT1/4-19	25	9	11	6.5	8.8	14
ACS-JWG28-38	PT1/4-19	PT3/8-19	28.5	11	12	8.8	11.8	17
ACS-JWG38-48	PT3/8-19	PT1/2-14	33	12	15	11.8	14.8	21
ACS-JWG48-68	PT1/2-14	PT3/4-14	40	15	17	14.8	20	27

Niple Doble Adaptador Hembra

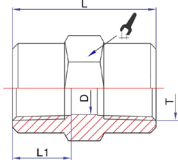

Modelo	T	L	L1	D	
ACS-JN-18	PT1/8-28	22	9	8	14
ACS-JN-28	PT1/4-19	26	11	10.8	17
ACS-JN-38	PT3/8-19	30	12	14	21
ACS-JN-48	PT1/2-14	34	15	17.5	24

TAPÓN HEXAGONAL

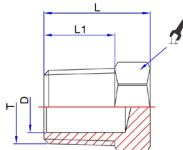

Modelo	T	L	L1	D	
ACS-JD-18	PT1/8-28	13.5	9	6.5	10
ACS-JD-28	PT1/4-19	16	11	8.8	14
ACS-JD-38	PT3/8-19	17.5	12	11.8	17
ACS-JD-48	PT1/2-14	21	15	14.8	21
ACS-JD-68	PT3/4-14	25	17	20	27

TAPÓN HEXAGONO INTERNO (LLAVE ALLEN)

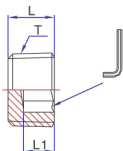

Modelo	T	L	L1	
ACS-JDN-18	PT1/8-28	6	4	5
ACS-JDN-28	PT1/4-19	7.5	5.5	6
ACS-JDN-38	PT3/8-19	8.5	6.5	8
ACS-JDN-48	PT1/2-14	12	9	10

ACCESORIOS

Adaptadores.

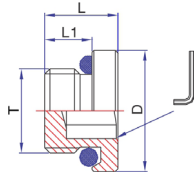

TAPÓN HEXAGONAL CUERDA "G"

Modelo	T	L	L1	D	
ACS-JDG-18	PT1/8-28	8.5	5.5	14	4
ACS-JDG-28	PT1/4-19	10	6.5	17	6
ACS-JDG-38	PT3/8-19	10.5	6.5	20	10
ACS-JDG-48	PT1/2-14	14.5	10	24	12

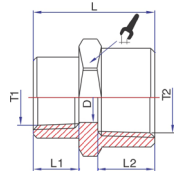

Adaptador Hembra

Modelo	T1	T2	L	L1	L2	D1	
ACS-JNG18-28	PT1/8-28	PT1/4-19	24	9	11	8	17
ACS-JNG28-38	PT1/4-19	PT3/8-19	28	11	12	10.8	21
ACS-JNG38-48	PT3/8-19	PT1/2-14	32	12	15	14	24

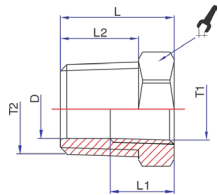

Adaptador Macho/Hembra

Modelo	T1	T2	L	L1	L2	D	
ACS-JNW18-28	PT1/8-28	PT1/4-19	16	9	11	8	14
ACS-JNW28-38	PT1/4-19	PT3/8-19	17.5	11	12	10.8	17
ACS-JNW38-48	PT3/8-19	PT1/2-14	21	12	15	14	21
ACS-JNW48-68	PT1/2-14	PT3/4-14	25	15	17	18	27

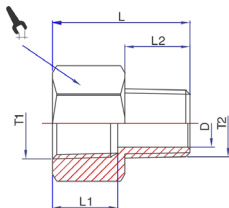

Adaptador Hembra/Macho

Modelo	T1	T2	L	L1	L2	D	
ACS-JFW18-18	PT1/8-28	PT1/8-28	20	9	9	6.5	14
ACS-JFW28-18	PT1/4-19	PT1/8-28	22	11	9	6.5	17
ACS-JFW28-28	PT1/4-19	PT1/4-19	24	11	11	8.8	17
ACS-JFW38-28	PT3/8-19	PT3/8-19	25	12	11	8.8	21
ACS-JFW38-38	PT3/8-19	PT3/8-19	26	12	12	11.8	21
ACS-JFW48-38	PT1/2-14	PT3/8-19	29	15	12	11.8	24
ACS-JFW48-48	PT1/2-14	PT1/2-14	32	15	15	14.8	24

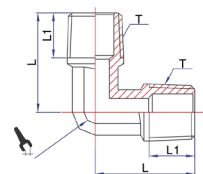

Doble Codo Macho 90

Modelo	T	L	L1	
ACS-JWU-18	PT1/8-28	17.6	8	7
ACS-JWU-28	PT1/4-19	21.2	10	8
ACS-JWU-38	PT3/8-19	25	11	12
ACS-JWU-48	PT1/2-14	29.5	14	14



Pistola Sopleteadora

Modelo	Material	Color
AG1-01-B	100mm	NEGRO
AG1-02-R	100mm	ROJO
AG1-01-BL	100mm	AZUL
AG2-02-B	200mm	NEGRO
AG2-01-R	200mm	ROJO
AG2-02-BL	200mm	AZUL



Pistola para Aire Premium

Modelo	Material	Color
AG2-BL	Plástico	Azúl
AG2-GY	Plástico	Gris



Cortador de Tubo

Modelo	Material	Color
QA-8	Plástico	Azúl



Cortador de tubo con flexómetro

Modelo	Material	Color
CT-II-GY	Plástico	Gris
CT-II-B	Plástico	Negro



PU - Manguera de Poliuretano

PU - Manguera de poliuretano

Métrico - Tubo Ø4 a 16 mm D.G.

Ventajas.

- Son Extremadamente Flexibles.
- Tienen un radio de curvatura pequeño, por lo que son adecuadas en lugares estrechos.
- Excelente memoria de recuperación, ya que se pueden doblar repetidamente sin dañarse.
- Super resistente, adecuada para transportar abrasivos, baja permeabilidad al gas y baja contaminación por fugas.
- Su gran resistencia evita los efectos de los químicos, agua, aceite combustibles, entre otros.

Especificaciones.

Material	Poliuretano
Fluido	Aire
Temperatura	-20° ~ 80 °C
Presión de trabajo	1 MPa
Presión de ruptura	2.5 MPa
NOTA	NO USAR CON GAS
Colores	Transparente, Negro, Azul Sólido, Rojo, Amarillo, Verde, Blanco, Naranja, Azul Traslúcido
Tubería	4, 6, 8, 10, 12, 14, 16 mm

Figura.

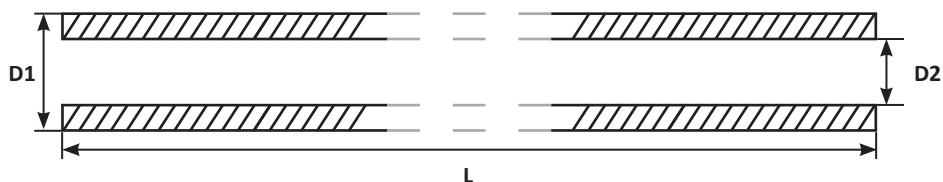

Modelo	D1	D2	L	Peso (kg/rollo)	Presión de trabajo a 20 °C	Presión de ruptura a 20 °C	Radio de curvatura mínimo
PU 4mm	4mm	2.5mm	200m	1.9	10 bar	25 bar	10mm
PU 6mm	6mm	4mm	200m	3.9	10 bar	25 bar	15mm
PU 8mm	8mm	5mm	100m	3.8	10 bar	25 bar	20mm
PU 10mm	10mm	6.5mm	100m	5.6	10 bar	25 bar	30mm
PU 12mm	12mm	8mm	100m	7.8	10 bar	25 bar	35mm
PU 14mm	14mm	10mm	100m	9.4	8 bar	25 bar	55mm
PU 16mm	16mm	12mm	100m	11	8 bar	25 bar	65mm

NOTA: Rango de tolerancia para rango de 4, 6, 8 mm (±0.1mm) y para 10, 12, 14, 16 mm (±0.15mm)

PU - Manguera de poliuretano

Métrico - Tubo Ø4 a 16 mm D.G.



MODELOS PARA ROLLO COMPLETO

MODELO	D.E.	COLOR
PU0004-200	4	Transparente
PU0006-200	6	Transparente
PU0008-100	8	Transparente
PU0010-100	10	Transparente
PU0012-100	12	Transparente
PU0014-100	14	Transparente
PU0016-100	16	Transparente
PU0104-200	4	Negro
PU0106-200	6	Negro
PU0108-100	8	Negro
PU0110-100	10	Negro
PU0204-200	4	Azul Solido
PU0206-200	6	Azul Solido
PU0208-100	8	Azul Solido
PU0210-100	10	Azul Solido
PU0212-100	12	Azul Solido
PU0214-100	14	Azul Solido
PU0216-100	16	Azul Solido
PU0304-200	4	Rojo
PU0306-200	6	Rojo
PU0308-100	8	Rojo
PU0310-100	10	Rojo
PU0404-200	4	Amarillo
PU0406-200	6	Amarillo
PU0408-100	8	Amarillo
PU0410-100	10	Amarillo
PU0504-200	4	Verde
PU0506-200	6	Verde
PU0508-100	8	Verde
PU0510-100	10	Verde
PU0604-200	4	Blanco
PU0606-200	6	Blanco
PU0608-100	8	Blanco
PU0610-100	10	Blanco
PU0704-200	4	Naranja
PU0706-200	6	Naranja
PU0708-100	8	Naranja
PU0710-100	10	Naranja
PU0804-200	4	Azul Traslucido
PU0806-200	6	Azul Traslucido
PU0808-100	8	Azul Traslucido
PU0810-100	10	Azul Traslucido
PU0812-100	12	Azul Traslucido
PU0814-100	14	Azul Traslucido
PU0816-100	16	Azul Traslucido

PU - Manguera de poliuretano

Pulgadas- Tubo $\varnothing 5/32''$ a $1/2''$ D.G.

Ventajas.

- Son Extremadamente Flexibles.
- Tienen un radio de curvatura pequeño, por lo que son adecuadas en lugares estrechos.
- Excelente memoria de recuperación, ya que se pueden doblar repetidamente sin dañarse.
- Super resistente, adecuada para transportar abrasivos, baja permeabilidad al gas y baja contaminación por fugas.
- Su gran resistencia evita los efectos de los químicos, agua, aceite combustibles, entre otros.

Especificaciones.

Material	Poliuretano
Fluido	Aire
Temperatura	-20° ~ 80 °C
Presión de trabajo	1 MPa
Presión de ruptura	2.5 MPa
NOTA	NO USAR CON GAS
Colores	Transparente, Negro, Azul Sólido, Azul Traslúcido
Tubería	5/32", 1/4", 5/16", 3/8", 1/2"

Figura.

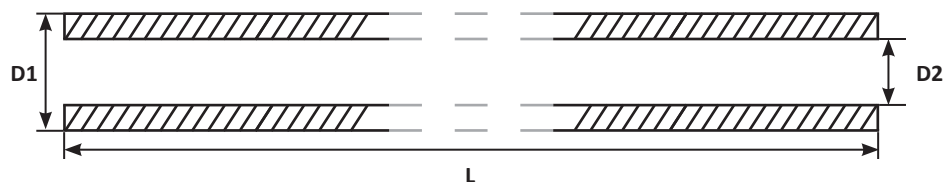

Modelo	D1	D2	L	Peso (kg/rollo)	Presión de trabajo a 20 °C	Presión de ruptura a 20 °C	Radio de curvatura mínimo
PU 5/32	3.94mm	2.5mm	200m	1.9	10 bar	25 bar	10mm
PU 1/4	6.35mm	4.23mm	200m	4.4	10 bar	25 bar	15mm
PU 5/16	7.94mm	5mm	100m	3.8	10 bar	25 bar	20mm
PU 3/8	9.52mm	6.35mm	100m	4.9	10 bar	25 bar	30mm
PU 1/2	12.7mm	8.46mm	100m	8.8	10 bar	25 bar	35mm

NOTA: Rango de tolerancia para rango de 5/32, a 3/8 ($\pm 0.005''$) y para 1/2 ($\pm 0.007''$)

PU - Manguera de poliuretano

Pulgadas- Tubo $\varnothing 5/32''$ a $1/2''$ D.G.



MODELOS PARA ROLLO COMPLETO

MODELO	D.E.	COLOR
PU00-5/32-200	5/32	Transparente
PU00-1/4-200	1/4	Transparente
PU00-5/16-100	5/16	Transparente
PU00-3/8-100	3/8	Transparente
PU00-1/2-100	1/2	Transparente
PU01-5/32-200	5/32	Negro
PU01-1/4-200	1/4	Negro
PU01-5/16-100	5/16	Negro
PU01-3/8-100	3/8	Negro
PU01-1/2-100	1/2	Negro
PU02-5/32-200	5/32	Azul Solido
PU02-1/4-200	1/4	Azul Solido
PU02-5/16-100	5/16	Azul Solido
PU02-3/8-100	3/8	Azul Solido
PU02-1/2-100	1/2	Azul Solido
PU08-5/32-200	5/32	Azul Traslucido
PU08-1/4-200	1/4	Azul Traslucido
PU08-5/16-100	5/16	Azul Traslucido
PU08-3/8-100	3/8	Azul Traslucido
PU08-1/2-100	1/2	Azul Traslucido

A close-up photograph of a coiled polyurethane (PU) hose. The hose is primarily yellow, with a section of red hose visible in the foreground. A metal fitting, consisting of a hexagonal nut and a threaded end, is attached to the red section of the hose. The background is dark, making the bright colors of the hose stand out.

PU - Manguera de Poliuretano

PU - Manguera de poliuretano en Espiral (Retractable)

Métrico - Tubo Ø6, 8, 10, 12 mm D.E.

Ventajas.

- Son Extremadamente Flexibles.
- Tienen un radio de curvatura pequeño, por lo que son adecuadas en lugares estrechos.
- Excelente memoria de recuperación, ya que se pueden doblar repetidamente sin dañarse.
- Super resistente, adecuada para transportar abrasivos, baja permeabilidad al gas y baja contaminación por fugas.
- Su gran resistencia evita los efectos de los químicos, agua, aceite combustibles, entre otros.

Especificaciones.

Material	Poliuretano
Fluido	Aire
Temperatura	-20° ~ 80 °C
Presión de trabajo	1 MPa
Presión de ruptura	2.5 MPa
NOTA	NO USAR CON GAS
Colores	Negro, Azul Sólido, Rojo, Amarillo
Tubería	6, 8, 10, 12 mm

Modelo	D1	DE	Largo (Metros)
PU 6m-R	4mm	6mm	6, 9, 12
PU 8m-R	5mm	8mm	6, 9, 12
PU 10m-R	6.5mm	10mm	6, 9, 12
PU 12m-R	8mm	12mm	6, 9, 12

NOTA: Rango de tolerancia para rango de 4, 6, 8 mm ($\pm 0.1\text{mm}$) y para 10, 12, 14, 16 mm ($\pm 0.15\text{mm}$)

PU - Manguera de poliuretano en Espiral (Retractivil)

Métrico - Tubo Ø6, 8, 10, 12 mm D.E.

MODELOS PARA ROLLO COMPLETO

MODELO	D.E.	COLOR
PU0106-06R	6	Negro
PU0106-09R	6	Negro
PU0106-012R	6	Negro
PU0108-06R	8	Negro
PU0108-09R	8	Negro
PU0108-012R	8	Negro
PU0110-06R	10	Negro
PU0110-09R	10	Negro
PU0110-012R	10	Negro
PU0112-06R	12	Negro
PU0112-09R	12	Negro
PU0112-012R	12	Negro
PU0206-06R	6	Azul Solido
PU0206-09R	6	Azul Solido
PU0206-012R	6	Azul Solido
PU0208-06R	8	Azul Solido
PU0208-09R	8	Azul Solido
PU0208-012R	8	Azul Solido
PU0210-06R	10	Azul Solido
PU0210-09R	10	Azul Solido
PU0210-012R	10	Azul Solido
PU0212-06R	12	Azul Solido
PU0212-09R	12	Azul Solido
PU0212-012R	12	Azul Solido
PU0306-06R	6	Rojo
PU0306-09R	6	Rojo
PU0306-012R	6	Rojo
PU0308-06R	8	Rojo
PU0308-09R	8	Rojo
PU0308-012R	8	Rojo
PU0310-06R	10	Rojo
PU0310-09R	10	Rojo
PU0310-012R	10	Rojo
PU0312-06R	12	Rojo
PU0312-09R	12	Rojo
PU0312-012R	12	Rojo
PU0406-06R	6	Amarillo
PU0406-09R	6	Amarillo
PU0406-012R	6	Amarillo
PU0408-06R	8	Amarillo
PU0408-09R	8	Amarillo
PU0408-012R	8	Amarillo
PU0410-06R	10	Amarillo
PU0410-09R	10	Amarillo
PU0410-012R	10	Amarillo
PU0412-06R	12	Amarillo
PU0412-09R	12	Amarillo
PU0412-012R	12	Amarillo





PE - Manguera de Polietileno

PE - Manguera de Polietileno

Métrica - Tubo Ø4 a 12 mm D.E.

Ventajas.

- La Tubería PE (Polietileno) de baja densidad ha sido utilizada durante muchos años para diferentes aplicaciones, entre los más comunes se encuentran:
- Transporte de Cerveza y bebidas no alcohólicas, agua destilada servicios de agua doméstica, etc. Este tipo de tubería es recomendada debido a su alta resistencia a productos químicos.
- Entre otras ventajas se encuentra la flexibilidad, alta resistencia química, bajo costo.

Especificaciones.

Material	Polietileno
Fluido	Aire
Temperatura	-20° ~ 60 °C
Presión de trabajo	1 MPa
Presión de ruptura	2.5 MPa
Colores	Transparente, Azul Sólido
Tubería	4, 6, 8, 10, 12 mm

Figura.

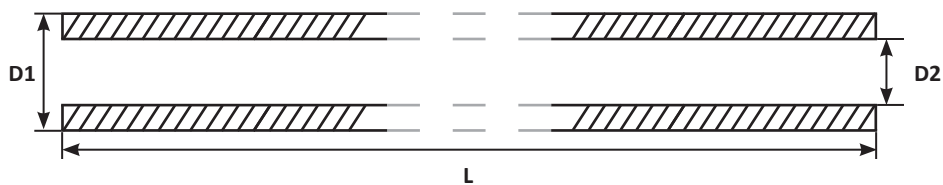

Modelo	D1	D2	L	Peso (kg/rollo)	Presión de trabajo a 20 °C	Presión de ruptura a 20 °C
PE 4mm	4mm	2.5mm	200m	1.37	8bar	25bar
PE 6mm	6mm	4mm	200m	2.8	8bar	25bar
PE 8mm	8mm	5mm	100m	1.97	8bar	25bar
PE 10mm	10mm	7.5mm	100m	3.6	8bar	25bar
PE 12mm	12mm	9mm	100m	4.4	8bar	25bar

PE - Manguera de Polietileno

Métrica - Tubo \varnothing 4 a 12 mm D.E.



MODELOS PARA ROLLO COMPLETO		
MODELO	D.E.	COLOR
PE0004-200	4	Transparente
PE0006-200	6	Transparente
PE0008-200	8	Transparente
PE0010-200	10	Transparente
PE0012-200	12	Transparente
PE0204-200	4	Azul Solido
PE0206-200	6	Azul Solido
PE0208-100	8	Azul Solido
PE0210-100	10	Azul Solido
PE0212-100	12	Azul Solido



PA - Manguera de Nylon

PA - Manguera de Nylon

Métrica - Tubo $\varnothing 4$ a 12 mm D.G.

Ventajas.

- Resistencia a presiones altas, transporte de químicos, sistema de aire comprimido, sistema de frenos de aire.
- Este material también ofrece una excelente resistencia a los abrasivos.
- Gran variedad de colores y diámetros.

Especificaciones.

Material	Nylon
Fluido	Solventes, Agua, Aire, Aceite
Temperatura	-40° ~ 80 °C
Presión de trabajo	20 bar
Presión de ruptura	60 bar
Colores	Transparente, Negro, Azul, Rojo
Tubería	4, 6, 8, 10, 12 mm

Figura.

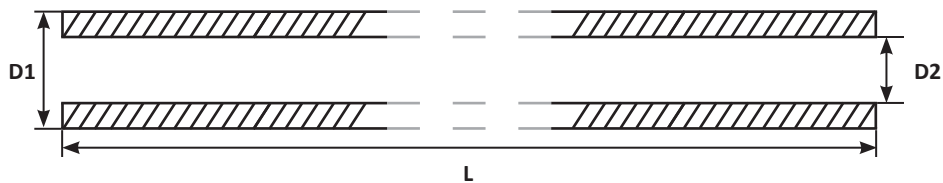

Modelo	D1	D2	L	Peso (kg/rollo)	Presión de trabajo a 20 °C	Presión de ruptura a 20 °C	Radio de curvatura mínimo
PA 4mm	4mm	2.5mm	200m	1.6	20bar	60bar	15mm
PA 6mm	6mm	4mm	200m	3.3	20bar	60bar	20mm
PA 8mm	8mm	6mm	100m	2.3	20bar	60bar	30mm
PA 10mm	10mm	8mm	100m	3	20bar	60bar	45mm
PA 12mm	12mm	10mm	100m	3.6	20bar	60bar	55mm

PA - Manguera de Nylon

Métrica - Tubo Ø4 a 12 mm D.G.



MODELOS PARA ROLLO COMPLETO

MODELO	D.E.	COLOR
PA0004-200	4	Transparente
PA0006-200	6	Transparente
PA0008-100	8	Transparente
PA0010-100	10	Transparente
PA0012-100	12	Transparente
PA0104-200	4	Negro
PA0106-200	6	Negro
PA0108-100	8	Negro
PA0110-100	10	Negro
PA0112-100	12	Negro
PA0204-200	4	Azul Solido
PA0206-200	6	Azul Solido
PA0208-100	8	Azul Solido
PA0210-100	10	Azul Solido
PA0212-100	12	Azul Solido
PA0304-200	4	Rojo
PA0306-200	6	Rojo
PA0308-100	8	Rojo
PA0310-100	10	Rojo
PA0312-100	12	Rojo

A close-up photograph of several hoses. The top three hoses are black, and the bottom one is blue. The black hoses have a textured, slightly grainy surface, while the blue hose has a smoother finish. The hoses are arranged in a curved, overlapping pattern. The text 'PUH' is embossed on the black hoses. The background is dark, making the hoses stand out.

PUH - Manguera Anti Chispa

PUH - Manguera de Anti-chispa

Métrica - Tubo $\varnothing 6$ a 12 mm D.E.

Ventajas.

- Esta tubería se fabrica en poliuretano, con una capa retardante sintético, con el fin de mejorar la resistencia a las chispas o restos de soldadura.
- El material sintético utilizado grado V0 (UL94-V0) ayuda a prevenir daños en la tubería en las áreas de soldadura.

Especificaciones.

Material	Poliuretano (Interno), Retardante Sintético (Externo)
Fluido	Agua, Aire, Aceite
Temperatura	-20° ~ 80 °C
Presión de trabajo	10 bar
Presión de ruptura	30 bar
Colores	Negro, Azul Sólido, Verde, Rojo
Tubería	6, 8, 10, 12 mm

Figura.

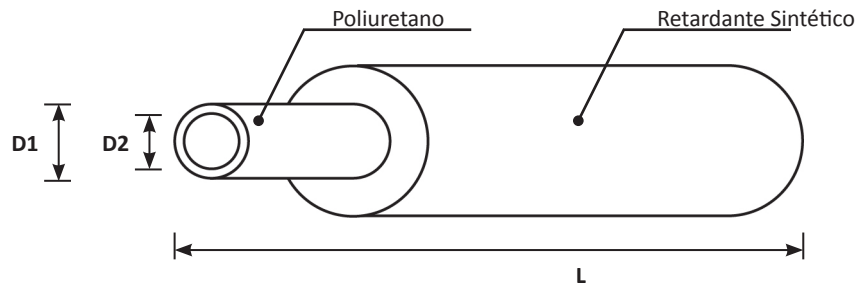

Modelo	D1	D2	L	Peso (kg/rollo)	Presión de trabajo a 20 °C	Presión de ruptura a 20 °C	Radio de curvatura mínimo
PUH 6mm	6mm	4mm	200m	5.6	10bar	30bar	15mm
PUH 8mm	8mm	5mm	100m	8.8	10bar	30bar	20mm
PUH 10mm	10mm	8mm	100m	11.5	10bar	30bar	30mm
PUH 12mm	12mm	10mm	100m	14	10bar	30bar	45mm

PUH - Manguera de Anti-chispa

Métrica - Tubo Ø6 a 12 mm D.E.

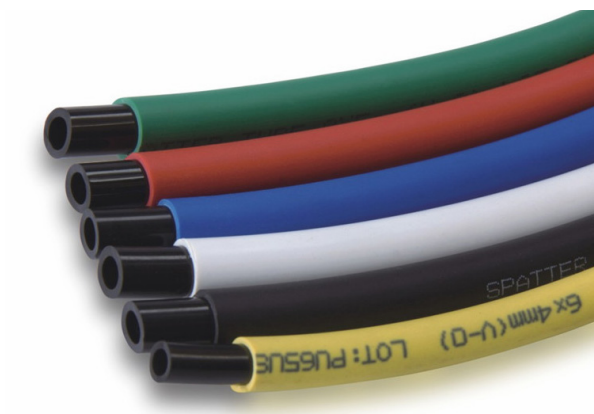

MODELOS PARA ROLLO COMPLETO

MODELO	D.E.	COLOR
PUH0104-200	6	Negro
PUH0106-200	8	Negro
PUH0108-100	10	Negro
PUH0110-100	12	Negro
PUH0206-200	6	Azul Solido
PUH0208-100	8	Azul Solido
PUH0210-100	10	Azul Solido
PUH0212-100	12	Azul Solido
PUH0304-200	6	Rojo
PUH0306-200	8	Rojo
PUH0308-100	10	Rojo
PUH0310-100	12	Rojo
PUH0504-200	6	Verde
PUH0506-200	8	Verde
PUH0508-100	10	Verde
PUH0510-100	12	Verde

N	PUR	PE	PVC		N	PUR	PE	PVC		N	PUR	PE	PVC		
-	4	1	4	Acetic Acid. Glacial	-	4	1	4	Ethylene Chloride	3	2	-	4	Picric Acid	
-	4	1	4	Acetic Acid. 30%	-	4	1	4	Ethylene Glycol	-	4	-	-	Potassium Acetate (aq)	
-	4	2	4	Acetone	-	4	2	4	Ethylene Oxide	-	1	1	1	Potassium Chloride (aq)	
-	4	1	1	Acetylene	-	4	1	1	Ethylene Trichloride	-	1	1	1	Potassium Cyanide (aq)	
-	4	-	-	Akazene	-	4	-	-	Ferric Chloride (aq)	3	4	1	1	PotassiumHydroxide (aq)	
-	3	2	1	Aluminum Choride (aq)	-	3	2	1	Ferric Nitrate (aq)	-	1	1	1	Producer Gas	
-	-	-	-	Aluminum Nitrate (aq)	-	3	-	-	Ferric Sulfate (aq)	1	3	3	1	Propane	
-	4	2	1	Ammonia Anhyarous	-	4	2	1	Fluorine (Liqued)	-	4	-	-	Propyl Alcohol	
-	3	-	-	Ammonia Gas (Cold)	-	3	-	-	Formaldehyde (RT)	-	4	-	-	Propylene	
-	4	-	-	Ammonia Gas (Hot)	-	4	-	-	Formic Acid	-	4	-	-	Propylene Oxicde	
-	1	1	1	Ammonium Chloride (aq)	-	1	1	1	Freon 11	-	4	-	-	Pydraul, 10E, 29 ELT	
-	1	1	1	Ammonium Sulfate (aq)	-	1	1	1	Freon 12	-	4	-	-	Pydraul 30E, 50E, 65E	
-	-	-	-	Amyl Alcohol	-	4	2	1	Freon 22	-	4	-	-	Pydraul, 115E	
-	4	-	-	Amyl Naphthalene	-	4	-	-	Fuel Oil	-	4	-	-	Pydraul 230E, 312C, 540C	
-	1	-	-	Animal Fats	-	1	-	-	Futural Glucose	-	2	-	-	Rapeseed Oil	
-	4	2	3	Aqua Regia	-	4	2	3	Glue	-	1	-	-	Red Oil (MIL-H-5606)	
-	3	2	1	Arsenic Acid	-	3	2	1	Glycerin	-	1	-	-	RJ-1 (MIL-F-2338 B)	
-	2	1	1	Asphalt	-	2	1	1	Glycols	-	1	-	-	RP-1 (MIL-F-25576 C)	
-	2	-	-	ASTM Fuel A	-	2	-	-	Green Sultate Liquor	-	-	-	-	Salt Water	
-	3	-	-	ASTM Fuel B	-	3	-	-	Hexane	1	2	1	1	Sewage	
-	3	1	1	ASTM Fuel C	-	3	1	1	Hydraulic Oil	-	4	-	-	Silicate Esters	
-	1	1	1	Barium Choride (aq)	-	1	1	1	Hydrochloric Acid (cold) 37%	-	1	-	-	Silicone Oils	
1	2	1	1	Beer	1	2	1	1	Hydrochloric Acid (hot) 37%	-	1	1	1	Silver Nitrate	
-	4	1	1	Beet Sugar Liquors	-	4	1	1	Hydrofluoric Acid (Conc.) Cold	-	1	2	1	Skydrol 500	
1	3	3	3	Benzene	1	3	3	3	Hydrofluoric Acid (Conc.) Hot	-	4	-	-	Skydrol 700	
-	2	-	-	Benzine	-	2	-	-	Hydrogen Gas	-	1	3	3	1	Soap Solutions
-	4	-	-	Blast Furnace Gas	-	4	-	-	Isobutyl Alcohol	1	3	3	1	Sodium Chloride (aq)	
-	4	-	1	Bleac Solutions	-	4	-	1	Isocotane	1	1	1	1	Sodium Hydroxide (aq)	
-	1	1	2	Borax	-	1	1	2	Isopropyl Acetate	2	4	2	1	Sodium Peroxide (aq)	
-	1	1	1	Boric Acid	-	1	1	1	Isopropyl Alcohol	-	4	1	2	Sodium Phosphate(aq)	
-	-	-	-	Brake Fluid	-	-	-	-	Isopropyl Ether	-	1	-	-	Sodium Sultate (aq)	
-	2	4	3	Brine	-	2	4	3	Kerosene	-	2	1	1	Soy Bean Oil	
4	4	-	-	Bromine Water	4	4	-	-	Lacquer	-	4	-	-	Steam Under 300°F	
-	2	-	-	Bunker Oil	-	2	-	-	Lacquer Solvents	4	4	-	-	Steam Over 300°F	
1	1	3	3	Butane	1	1	3	3	Lard	4	4	-	-	Stoddard Solvent	
-	1	-	-	Butter	-	1	-	-	Lavender Oil	-	1	3	3	Styrene	
3	4	1	2	Butyl Alcohol	3	4	1	2	Lead Acetate (aq)	-	3	-	-	Sucrose Soluttion	
-	4	1	1	Butylene	-	4	1	1	Linseed Oil	-	4	-	-	Sulfuric Acid (Dilute)	
1	1	2	1	Calcium Choride (aq)	1	1	2	1	Liquified Petrolateum Gos	-	3	1	1	Sulfuric Acid (Conc.)	
-	1	2	1	Calcium Hydroxide (aq)	-	1	2	1	Lubricating Oils	-	4	3	4	Sulfuric Acid (20% Oleum)	
1	1	-	-	Calcium Nitrate (aq)	1	1	-	-	Lye	-	4	2	1	Sulfurous Acid	
-	1	-	-	Calcium Sulfide (aq)	-	1	-	-	Magnesium Chloride (aq)	-	3	2	1	Tonic Acid	
-	4	-	1	Cane Sugar Liquors	-	4	-	1	Magnesium Hydroxide (aq)	-	1	2	1	Tetrochlorethlene	
-	3	2	3	Carbollic Acid	-	3	2	3	Mercury	-	4	2	4	Toluene	
-	1	3	1	Carbon Dioxide	-	1	3	1	Methane	1	4	3	4	Transformer Oil	
-	1	2	1	Carbonic Acid	-	1	2	1	Methyl Acetate	-	1	-	-	Transmission Fluid Type A	
-	1	2	1	Carbon Monoxide	-	1	2	1	Methyl Acrylate	3	4	-	3	Trichloroethane	
3	4	2	2	Carbon Tetrachloride	3	4	2	2	Methyl Alcohol	3	4	3	4	Trichtiroethylene	
-	-	-	-	Castor Oil	-	-	-	-	Methyl Butyl Ketone	-	-	-	-	Turbine Oil	
4	4	2	1	Chlorine (dry)	4	4	2	1	Methyl Cholride	-	1	3	-	Turpentine	
4	4	-	1	Chlorine(wet)	4	4	-	1	Methylene Cholride	1	4	3	2	Varnish	
3	4	3	4	Chloroform	3	4	3	4	Methyl Ethyl Ketone	-	3	3	4	Vinagar	
-	4	-	-	Chlorox	-	4	-	-	Methyl Isobutl Ktone	1	4	2	1	Vinyl Chloride	
4	4	1	1	Chromic Acid	4	4	1	1	Milk	-	4	-	-	Water	
1	1	1	2	Citric Acid	1	1	1	2	Mineral Oil	1	1	1	1	Whiskey	
-	3	-	-	Coal Tar	-	3	-	-	Naphtha	1	2	3	1	White Oil	
-	2	-	1	Coconut Oil	-	2	-	1	Naphtalene	-	1	-	-	Wood Oil	
-	1	-	1	Cod Liver Oil	-	1	-	1	Natural Gas	-	3	-	-	Xylene	
-	4	-	-	Coke Oven Gas	-	4	-	-	Neatsfoot Oil	2	4	3	4	Zinc Acetate (aq)	
-	1	2	1	Copper Chloride (aq)	-	1	2	1	Nitric Acid (Conc.)	-	4	1	-	Zinc Chloride(aq)	
-	-	-	-	Copper Chloride (aq)	-	-	-	-	Nitric Acid (Dilute)	1	1	-	-		
-	1	2	1	Com Oil	-	1	2	1	Nitroethane	-	-	-	-		
-	1	2	2	Cotton Seed Oil	-	1	2	2	Nitrogen	-	-	-	-		
4	4	3	4	Creosot	4	4	3	4	N-Octane	-	-	-	-		
1	1	2	4	Cychlohexane	1	1	2	4	Oleic Acid	-	-	-	-		
-	4	-	-	Denatured Aicohol	-	4	-	-	Oleum Spirits	-	-	-	-		
-	-	-	-	Detergent Solution	-	-	-	-	Olive Oil	-	-	-	-		
-	4	1	1	Diesel Oil	-	4	1	1	Oxygen-Cold	-	-	-	-		
-	3	3	1	Dioxane	-	3	3	1	Oxygen (200-400°F)	-	-	-	-		
-	4	-	-	Dowtherm Oil	-	4	-	-	Paint Thinner, Duco	-	-	-	-		
-	3	-	-	Dry Cteaning Fluid	-	3	-	-	Perchloric Acid	-	-	-	-		
-	4	-	-	Ethane	-	4	-	-	Perchloroethylene	-	-	-	-		
-	3	-	4		-	3	-	4		-	-	-	-		
-	-	-	-	Ethyl Acrylate	-	-	-	-	Petrolenm-Below 250°F	-	-	-	-		
-	4	-	-	Ethyl Alcohol	-	4	-	-	Petroleum-Above 250°F	-	-	-	-		
-	4	-	-	Ethyl Benzine	-	4	-	-	Phenol	3	4	-	-		
-	2	-	-	Ethyl Cellulose	-	2	-	-	Phenyl Ethyl Ether	-	-	-	-		
-	2	-	-	Ethyl Chlonde	-	2	-	-	Phosphoric Acid-45%	-	-	-	-		
-	3	-	-	Ethyl Ether	-	3	-	-	Pickling Soltion	-	-	-	-		

N Nylon
PUR Polyurethane Ether Base
PE Polyethylene
PVC Polyvinyl Chloride

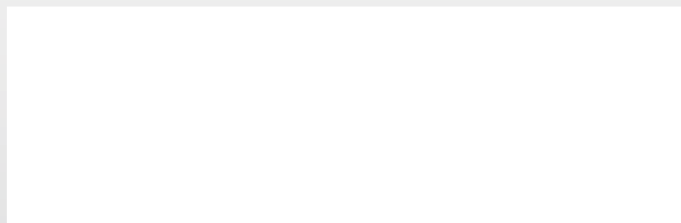

DE WIT
NEUMÁTICA